

# User Manual

**i-Thermo**



**i-Thermo 163M, 64M and i-Thermo 62L, 163L  
Revision Software th 3\_xx or higher**

## INDEX

<b>1</b>	<b>INSTALLATION INSTRUCTIONS</b> .....	<b>3</b>
<b>2</b>	<b>STORAGE CONDITIONS</b> .....	<b>5</b>
<b>3</b>	<b>PREPARING THE BALANCE TO WORK</b> .....	<b>6</b>
<b>4</b>	<b>KEYBOARD AND DISPLAY</b> .....	<b>7</b>
<b>5</b>	<b>INPUTS AND OUTPUTS</b> .....	<b>8</b>
5.1	REAR SIDE AND BOTTOM SIDE OF THE BALANCE MODEL I-THERMO .....	8
<b>6</b>	<b>WEIGHING</b> .....	<b>9</b>
6.1	STAND BY .....	9
6.2	SIMPLE WEIGHING .....	9
<b>7</b>	<b>CALIBRATION</b> .....	<b>10</b>
7.1	EXTERNAL CALIBRATION BALANCES .....	10
7.1.1	<i>External calibration</i> .....	10
<b>8</b>	<b>TARE FUNCTION</b> .....	<b>12</b>
<b>9</b>	<b>HOW TO SET BALANCE'S FUNCTIONS</b> .....	<b>13</b>
9.1	MEASURE UNITS.....	13
9.2	SERIAL FUNCTION .....	14
9.3	TRANSMISSION SPEED SELECTION.....	16
9.4	SERVICE .....	17
9.5	AUTOZERO FUNCTION .....	19
9.6	FILTERS SELECTION.....	20
9.7	STABILITY FUNCTION.....	21
9.8	DISPLAY CONTRAT REGULATION.....	22
9.9	DISPLAY BACKLIGHT SETUP.....	23
9.10	SELECTION OF WORKING MODE WITH TABLET.....	24
9.11	CALIBRATION MODE.....	25
<b>10</b>	<b>HOW TO SET HEATER'S FUNCTIONS</b> .....	<b>26</b>
10.1	MEASURE FUNCTION .....	26
10.1.1	<i>Mode using a saved program</i> .....	27
10.1.2	<i>PrG time mode</i> .....	28
10.1.3	<i>PrG Auto Mode</i> .....	31
10.2	PRG SET FUNCTION.....	33
<b>11</b>	<b>RS232 INTERFACE FEATURES</b> .....	<b>35</b>
11.1	GENERAL FEATURES .....	35
11.2	CONNECTING THE BALANCE TO PC.....	35
11.3	TRANSMISSION FORMAT WHEN IN PC CONNECTION MODE.....	36
11.4	CONNECTION OF THE BALANCE WITH THE SERIAL PRINTER.....	37
11.5	PRINT FORMATS ON PAPER WITH SERIAL PRINTER .....	37
<b>12</b>	<b>CONNECTORS POSITION (REAR)</b> .....	<b>38</b>
<b>13</b>	<b>ERROR CODES</b> .....	<b>39</b>
<b>14</b>	<b>MAINTENANCE AND CARE</b> .....	<b>39</b>
<b>15</b>	<b>QUICK GUIDE TO BALANCE PARAMETERS SETTINGS</b> .....	<b>40</b>
<b>16</b>	<b>QUICK GUIDE TO THE USE OF THE BALANCE'S PROGRAMS</b> .....	<b>41</b>

**17 BALANCE TECHNICAL FEATURES.....42**  
**18 HEATER TECHNICAL FEATURES .....42**  
**19 WARRANTY.....43**  
**20 EQUIPMENT DISPOSAL.....43**

# 1 Installation instructions



## **WARNING:**

Please follow carefully these steps for installing and use the new balance before starting your work routine. A way of use of the instrument different from this user manual will not guarantee the instrument's safety anymore. Keep this manual in a safe place.

## **Please follow these indications to avoid problems and to grant a safe use of moisture analyzer:**

- Use the moisture analyzer exclusively for the moisture determination of samples. Every incorrect use of this instrument may create danger for safety of persons and may cause damages at the instrument or at other objects.
- Do not use the instrument in areas where there is danger of explosions; also make the instrument work only respecting the environment conditions as reported in this manual.
- If this material is used in plants or in environment conditions that require strict safety conditions, please respect the instructions of the directives regarding the installation of this material currently existing in your country.
- This instrument must be used only by qualified personell, who knows the features and characteristics of the sample under test.
- Before starting to work with the instrument for the first time, please check that voltage is the same of your electric mains.
- To get the instrument free from tension, remove the power supply cable.
- Place straight the power supply cable so that to avoid contact with the very hot surfaces of the instrument.
- Use only extension cables that are conform to normatives and that are equipped of a protection conductor.



## **Attention, protection against heat**

- Respect the distance and the free space around the instrument to avoid an accumulation of heat in the instrument and and the over heating of the instrument ifself:
  - 20 cm around the instrument
  - 1 m upon the instrument
- Do not place flammable materials upon, below or near the instrument since the heater warms the surrounding area.
- Remove the samples carefully, the heater and the dishes for samples may be still very hot.



## **Danger for persons or objects when working with particular samples: Fire Explosion**

- Flammable or explosive substances
- Substances that contain solvents
- Substances that during drying emit gas or flammable explosive vapors

- **Remove** the and verify if there are any visible damages to the instrument
- **Do not install** the balance in a place with air flows, heavy thermic changes and vibrations.
- **The humidity rate** of the balance environment must be between 45% and 75%

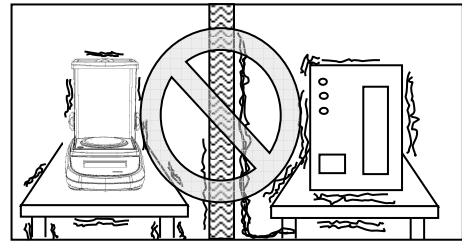
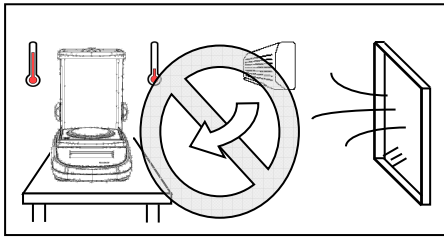

- **Place** the weighing pan and the support pan on the balance (see section 3).
- **Level** the balance using the level bubble and levelling feet located underneath the case

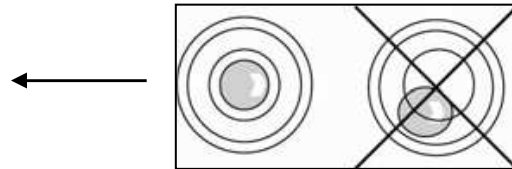
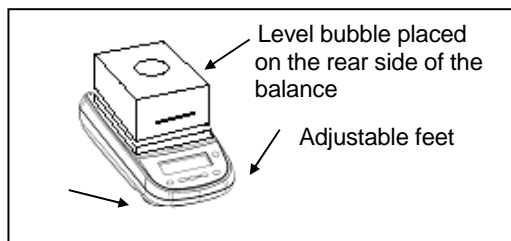

- **Connect** the power supply to the connector 2 place on the rear side of the balance and the cable of the heater on the right connector placed on the rear side of the heater (see sec. 5).
- **Connect** the power supply and the cable of the heater to an electric plug near the instrument, **that must be easily accesible**; after few seconds the balance will switch on by itself.
- **From switch on wait for 30 minutes** and then calibrate the balance using the calibration weight (if supplied), following the instructions (sec. 7)
- **Calibrate** the balance each time that it is moved from one place to another.
- **Check** periodically the calibration of the balance.
- **It is reccomended** not to let fall too heavy objects on the balance's pan, to avoid damaging the balance.
- **Service** must be effected by qualified personell and the spare parts used must be original. In order to comply with this it is necessary to call the reseller where the balance has been bought.

## 2 Storage conditions

- **Storage temperature** +5 °C...+40°C
- **Storage humidity** 45% - 75%.
- **Keep the balance's package** in the event that the balance must be sent to the service center, remove all cables and accessories to avoid any damage during transportation.
- **Keep the balance far** from extreme temperature and humidity, and avoid violent shocks.

### 3 Preparing the balance to work

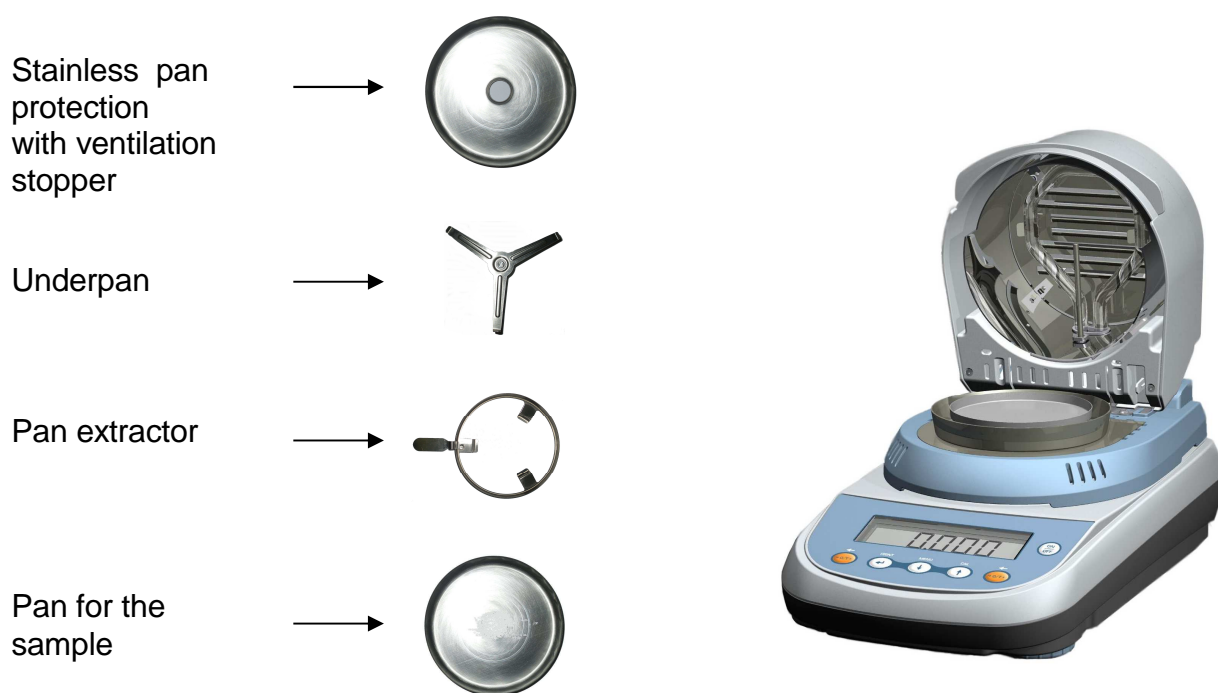

1. Insert stainless pan protection.
2. Insert underpan on the cone of weight.
3. Insert pan extractor
4. Put the pan for the sample.

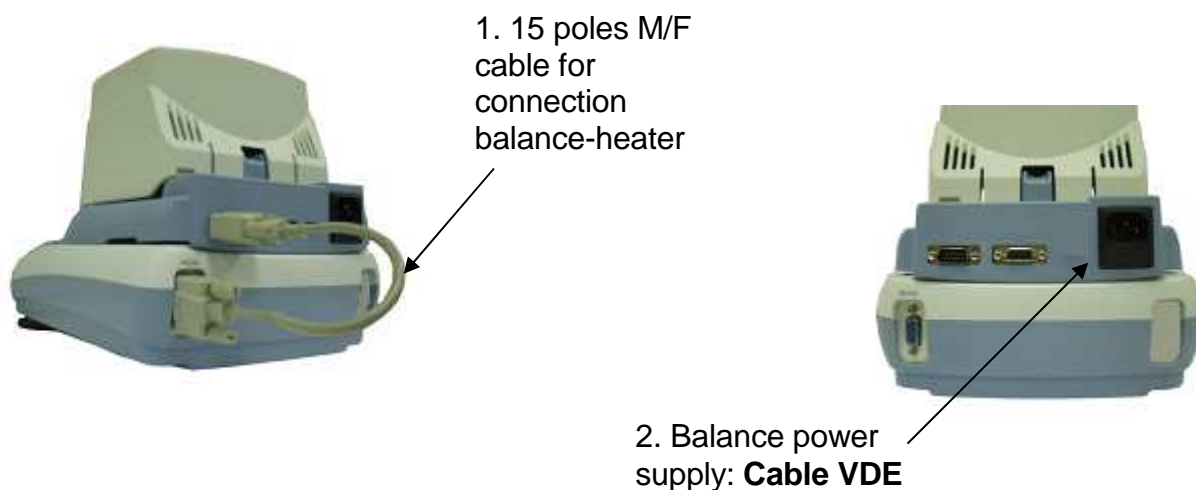

1. Connect the heater to the balance via cable 15-pin M / F, insert the cable into the two connectors on the rear of the instrument as shown in the figure.

2. Insert the VDE cable in the power connector on the back of the instrument

**N.B. Verify that the power supply indicated on the instrument nameplate matches the one in use in the country where you are installing.**

3. Then connect the VDE cord to the power outlet located near the instrument. Do not use non-compliant with current regulations cables / extensions.

## 4 Keyboard and display

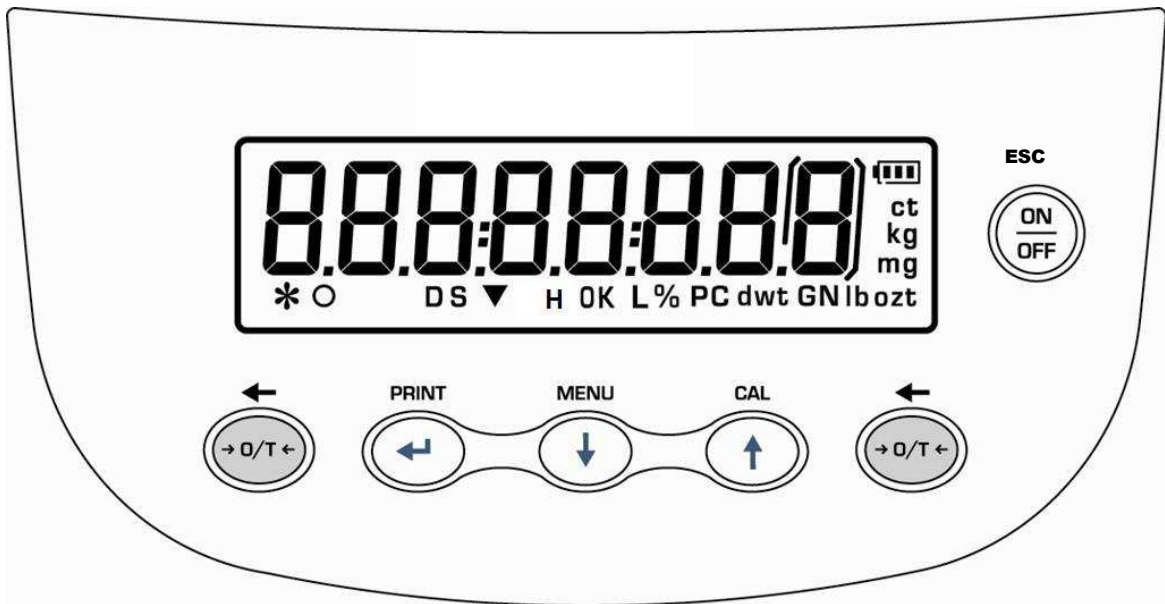

	<p>Standby (OFF) or power on (ON) button Escape function button (ESC).</p>	<p>* Stability indicator</p>
	<p>TARE or zero button .</p>	<p>O Zero indicator</p>
	<p>Selection CONFIRM or SEND data to printer button.</p>	<p>% Percentage weighing</p>
	<p>Balance setup MENU button, to set balance's parameters.</p>	<p> Battery charge indicator</p>
	<p>Balance CALIBRATION button.</p>	<p>▼ Insert data mode</p>
		<p>H Heater is working</p>
		<p>g Measure unit</p>



## 5 Inputs and outputs

### 5.1 Rear side and bottom side of the balance model I-Thermo

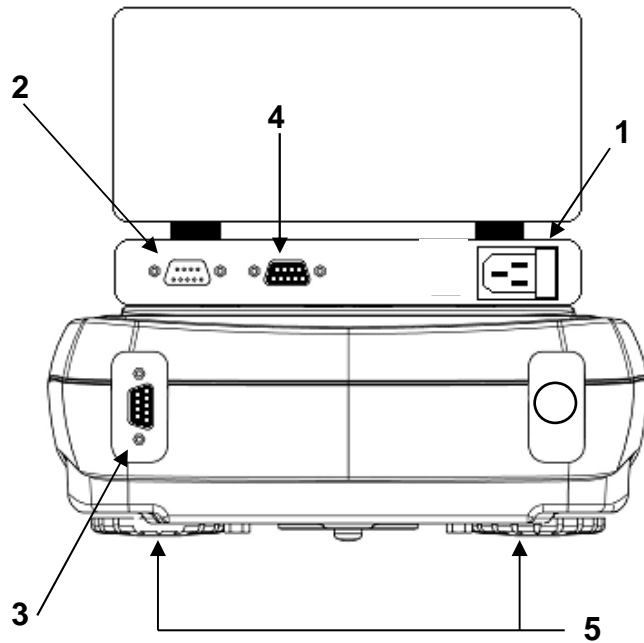

1. **CONNECTOR 1**  
Balance's power supply (VDE)
2. **CONNECTOR 2**  
Connect heater to balance.
3. **CONNECTOR 3**  
Connect balance to heater.
4. **CONNECTOR 4**  
9 pin RS232 Interface for PC and printer
5. **ADJUSTABLE FEET**

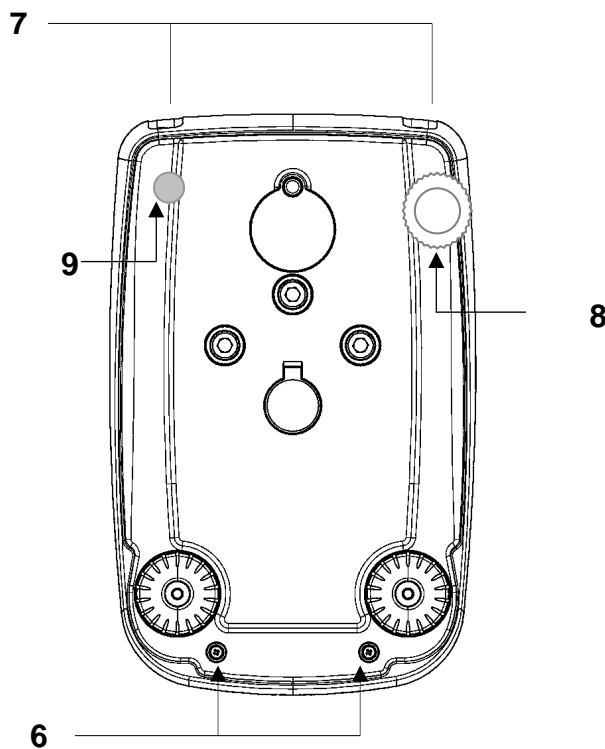

6. **N°2 closing screws of the balance**
7. **N°2 closing screws of the balance:** first remove the screws remove adjustabel rear feet(8) and fixed rear feet(9).
8. **Adjustable rear feet**
9. **Fixed rear feet**

## 6 Weighing

After having connected the balance to AC outlet, it will perform an internal circuits test, therefore that the balance will set itself in stand-by mode.



### 6.1 Stand By

From “**STAND BY**” mode:

- Press **ON/OFF** button to bring balance to work conditions.
- Press again **ON/OFF** button to return to “**STAND BY**” condition.



### 6.2 Simple weighing

Place the sample to weigh on the pan and read the value of weight on the display as soon as the symbol ✖ (asterisk) of stability appears



## 7 Calibration

Electronic balances operate mass measurements making use of gravity (g). Difference of latitude in geographic areas and altitude will vary gravity acceleration value (g). Therefore, for accurate measurements, the balance must be adjusted to the local environment. This adjustment is accomplished by calibration function.

### 7.1 External calibration balances

#### 7.1.1 External calibration

Calibration is accomplished by pressing CAL button.

1. Press **CAL** button when pan is empty, "CAL" are displayed on the display..

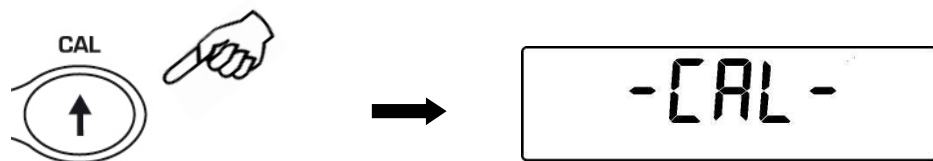

2. When calibration weight value starts to flash, load the weight on the pan.

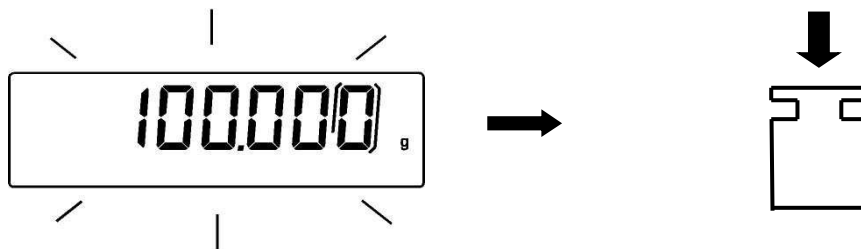

3. The display will stop flashing, indicating calibration weight value. Once the calibration is effected will be shown the value of the calibrated wight and the current unit of measure.
4. Unload calibration weight from the pan. The balance is ready for weighing operations

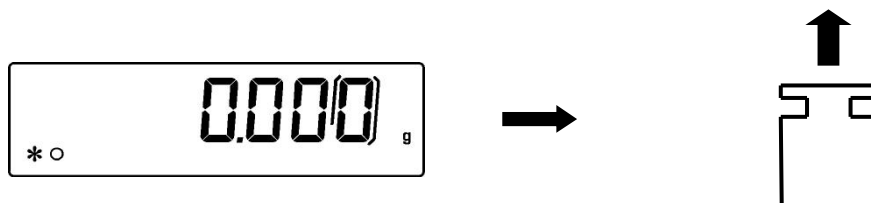

**NOTE:** if there is an interference during calibration process, an error message will be displayed.

Moreover, it is possible to calibrate the balance with a calibration weight higher than the one set by default:

1. Press and keep **CAL** button pressed with empty pan until the acoustic alarm stops,

then release the button. On display it will be visualized the string **"-CAL-"**, followed by flashing string **"LOAD"**.

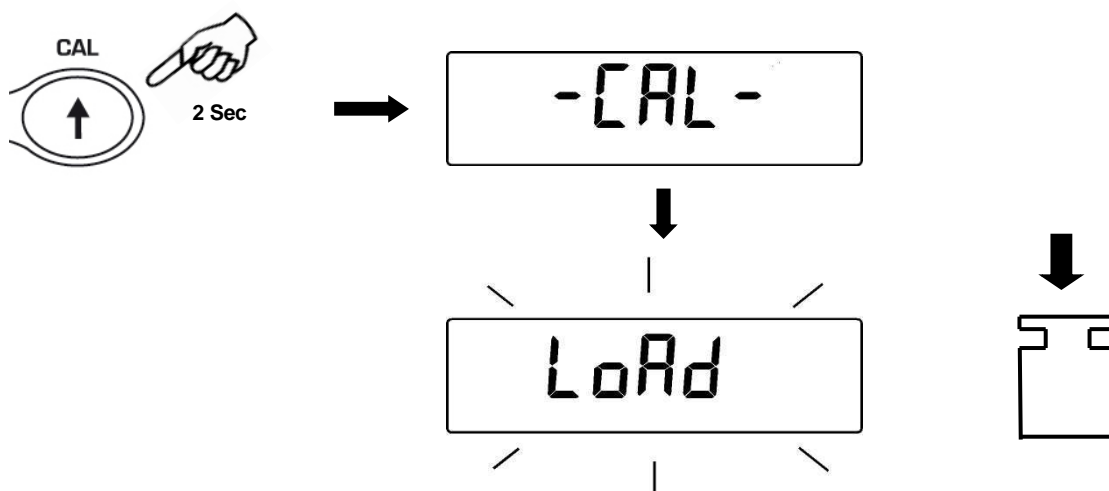

2. Load on the pan a weight equal higher or lower than default calibration weight, the balance will recognize it as valid weight if equal or higher than calibration weight as long as it is a whole number in comparison with the most meaningful digit of calibration weight.  
e.g.: if calibration weight is 100g, it will be possible to calibrate the balance with values from 10g 20g, 30g up to the highest limit of balance weighing range.  
The message **"LOAD"** on display will stop flashing, once calibration has been effected, the value of calibrated weight will be displayed.
3. Unload calibration weight. The balance is ready for weighing operations.

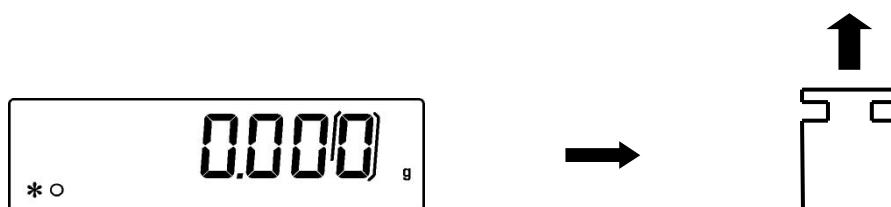

**NOTE:** if there is interference during calibration process, an error message will be displayed.

## 8 Tare function

1. Load the container on the pan. The display will show the weight



2. Press **O/T** button. “**O-t**” indication will be displayed

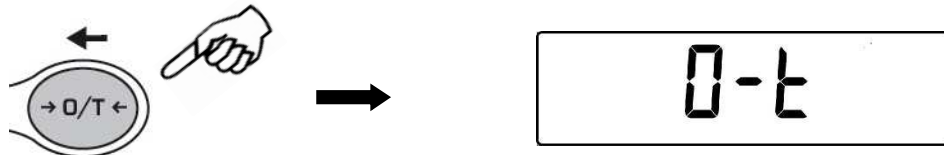

3. After reaching stability, the value “**0.000**” will be displayed. If the stability is not achieved, due to air flows or vibrations or other disturbs the “**O-t**” will remain displayed.



4. Load the objects to weigh in the container. Read net weight value on display



## 9 How to set Balance's functions

### 9.1 Measure units

From zero condition on display, press and keep pressed the MENU button until to buzzer sound stops, then release the button. The message "unitS" is displayed, then press PRINT button to confirm.

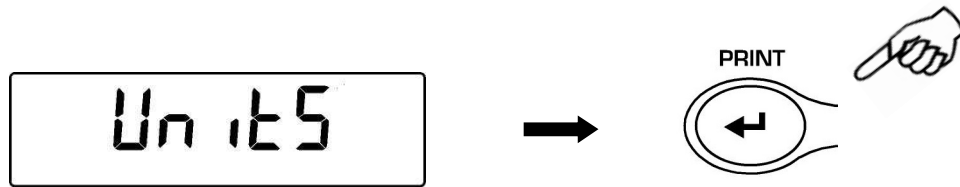

2. The message "GRAM" is displayed.

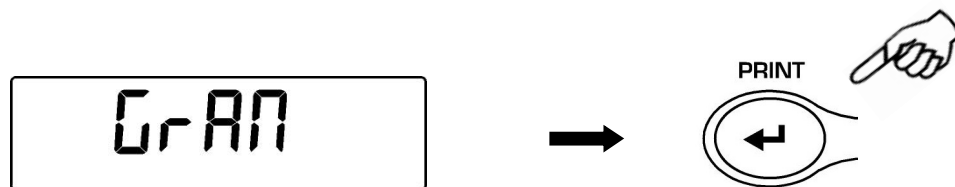

3. Press PRINT button to confirm

## 9.2 Serial function

This function allows you to select the different modes of data transmission.

1. From zero condition on display, press and keep pressed the **MENU** button until to buzzer sound stops, then release the button. The message “**unitS**” is displayed, then press **MENU** button until the message “**Serial**” is displayed and confirm by pressing the **PRINT** button.

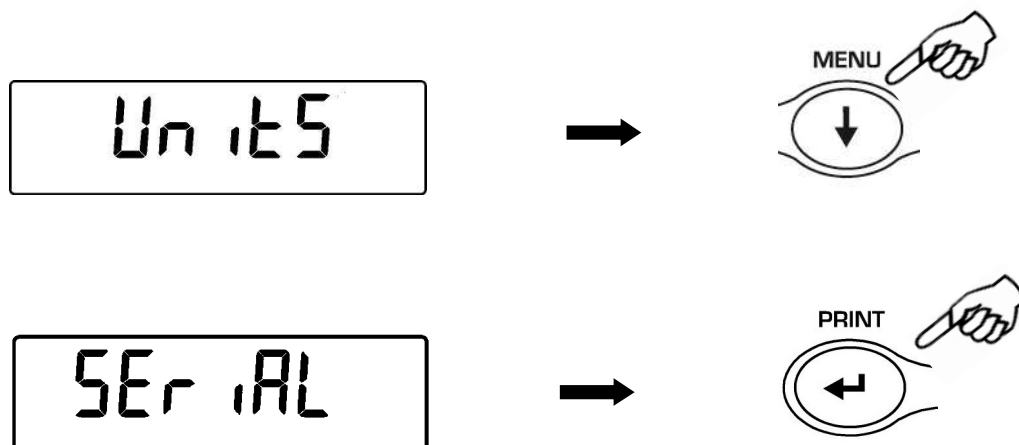

Transmission modes are the following:

Manu Prt	The print is accomplished only pushing the PRINT button.
Auto Prt	The print is accomplished automatically at the end of the test.
Manu Pc	The data are transmitted to the PC only after pressing the PRINT button.
Auto PC	The data are transmitted to the PC automatically at the end of the test.
Weig PC	The value of the weight is transmitted continuously to the PC.
Manu t50	Printing is done only by pressing the PRINT button. (for printer model TLP50).
Auto t50	Printing is done automatically at the end of the test (for printer model TLP50).

Pressing the MENU or CAL button scroll forward or backward the various methods of drying, select the one you want and confirm with PRINT button.

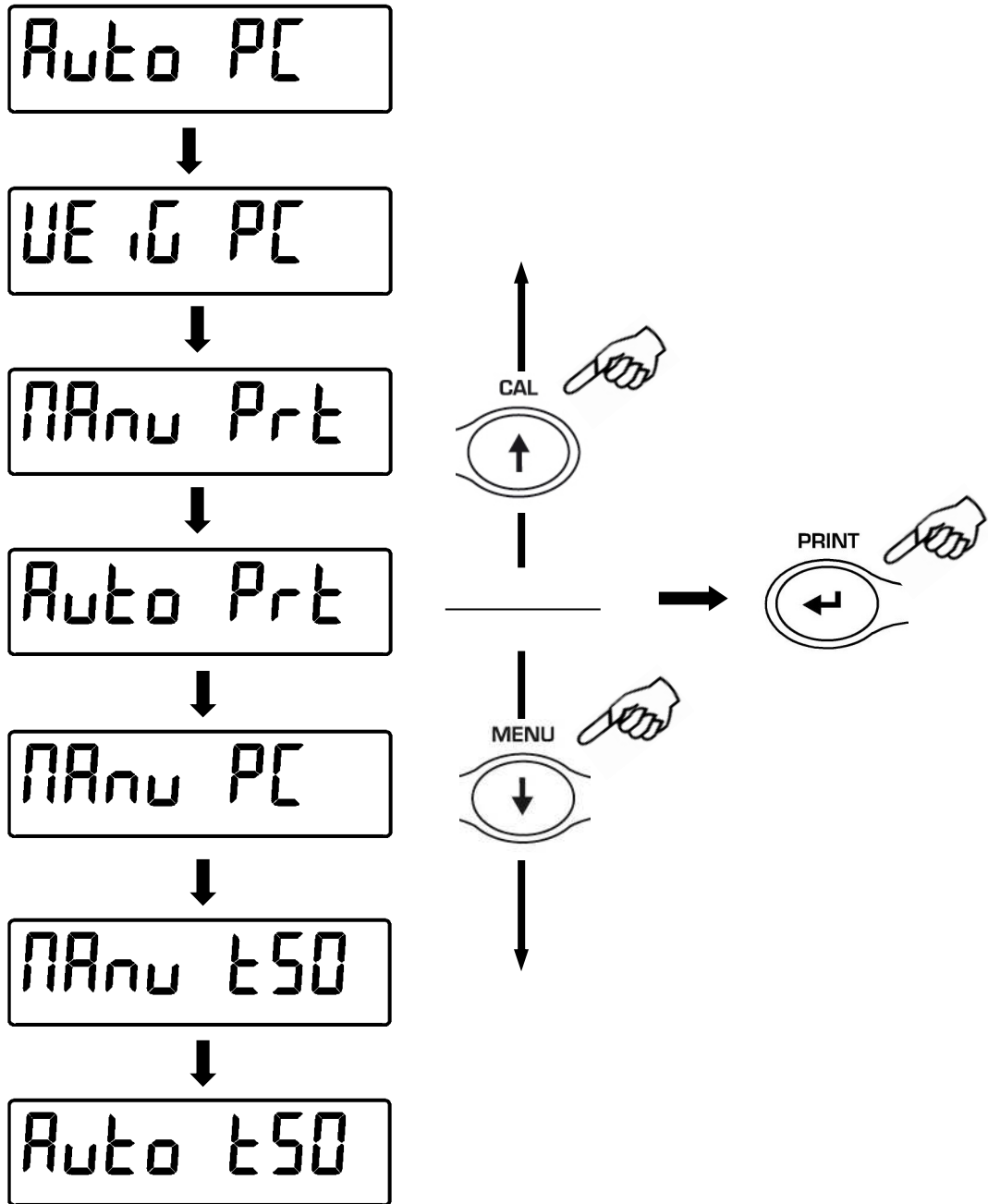

2. After selecting the desired mode press the MENU button to move to the next parameter or the CAL button to move to the previous one.

3. To exit the setup menu parameters, press the ON / OFF button.

4. The balance returns to normal weighing conditions





### 9.3 Transmission speed selection

1. From zero condition on display, press and keep pressed the **MENU** button until to buzzer sound off, then release the button. The message “unitS” is displayed, then press **MENU** button until the message “BAUD RT” is displayed and confirm by pressing the **PRINT** button.

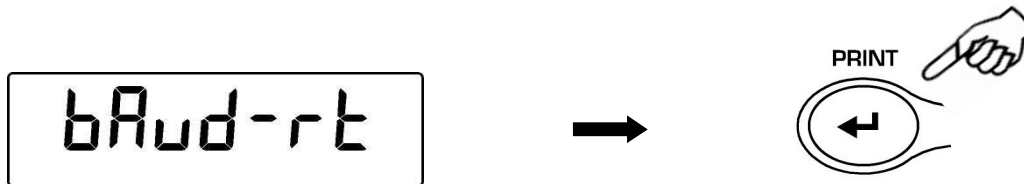

2. Select serial data transmission speed (1200-2400-4800-9600 baud). Pressing **MENU** or **CAL** buttons it will be possible to scroll forward or backward trough the different transimission speeds, then confirm your choice by pressing **PRINT** button.

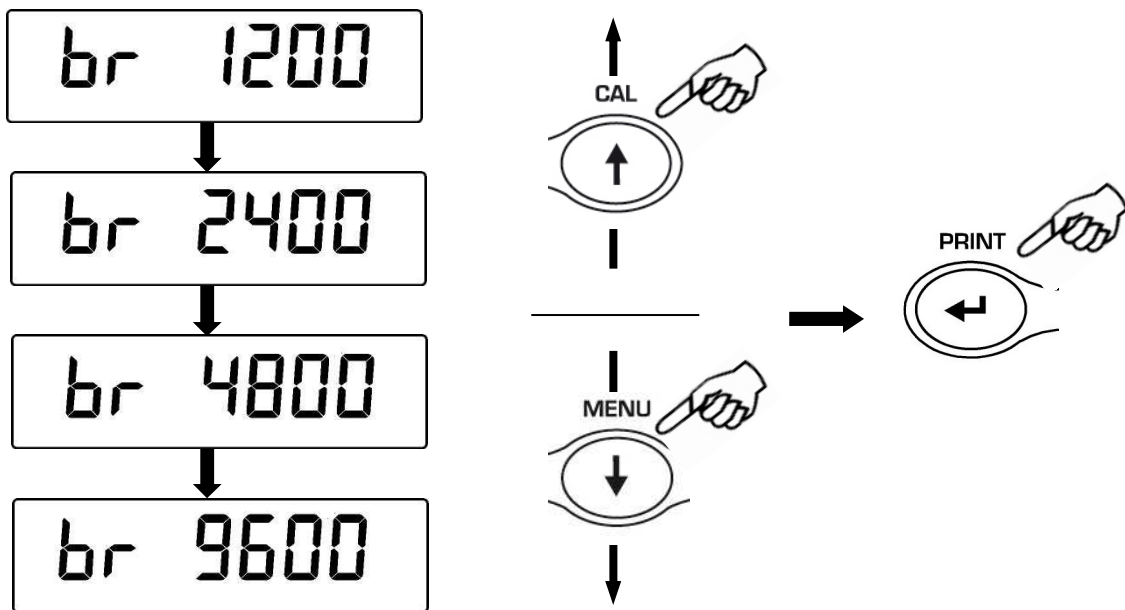

3. After having selected the transmission speed you wish, press the **MENU** button to go to next parameter or **CAL** button to go to previous one.
4. To escape from parameters setup menu, press the **ON/OFF** button
5. The balance will return to standard weighing condition



## 9.4 Service

1. From zero condition on display, press and keep pressed the **MENU** button until to buzzer sound stops, then release the button. The message “**unitS**” is displayed, then press **MENU** button until the message “**Service**” is displayed and confirm by pressing the **PRINT** button.

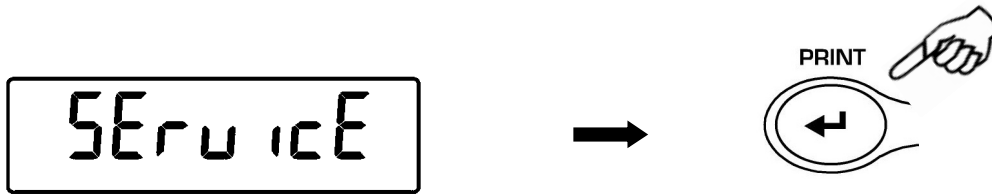

2. Verify the presence of the (optional) pan with the disc temperature sensor and attach the connector to the thermometer.

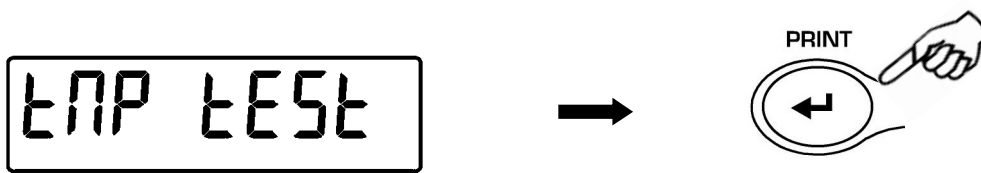

3. Confirm with **PRINT** button function of test temperature.

4. You can now set the desired temperature for the first test. First displayed value of 35°C that is the minimum value, use the **MENU** and **CAL** buttons to decrease / increase this value, then confirm the value by pressing the **ENTER** button.

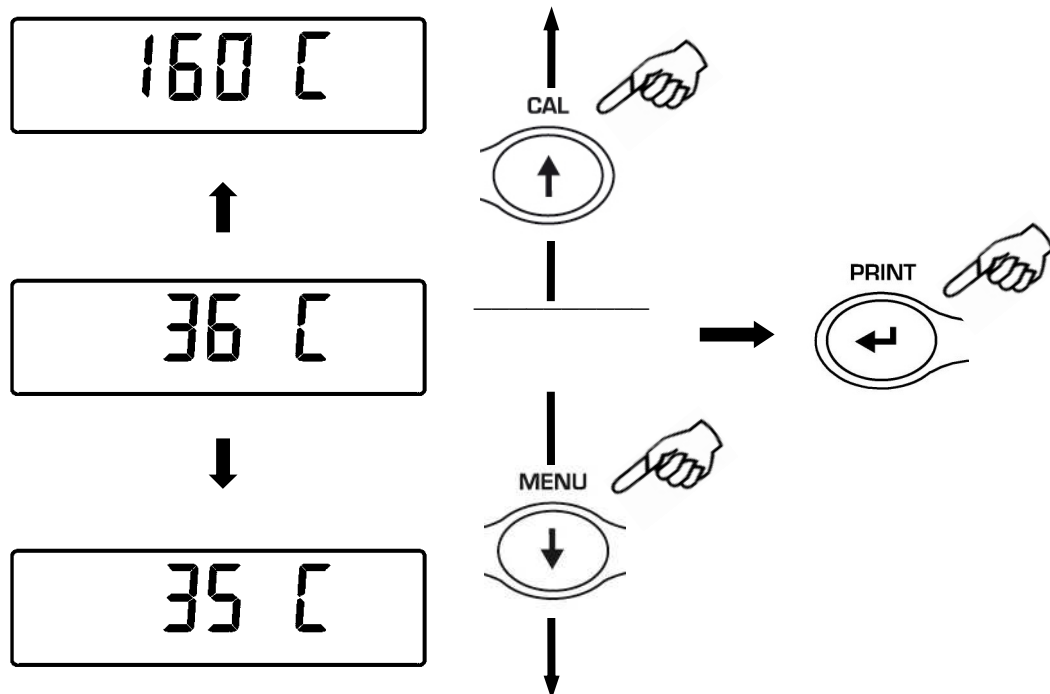

5. Now the heating cycle will start and the display will show the actual temperature value. The H symbol on indicates the heater is powered.



Once the value set is reached, leave the heater on for about 15 minutes, then compare the value on the display with the one detected by the external thermometer

To stop and exit the test mode, press the **ON/OFF** button.

The following menus are accessible only by technical staff:



THERMOMETER  
SETTING

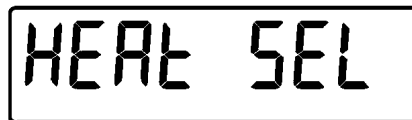

LIGHT  
SELECTION

## 9.5 Autozero function

Autozero is an automatic correction of a possible zero drift.

- **Au0 OFF** = autozero disabled
- **Au0 1** = soft autozero
- **Au0 2** = medium autozero
- **Au0 3** = heavy autozero
- **Au0 3E** = heavy autozero over all range

1. From zero condition on display, press and keep pressed the **MENU** button until to buzzer sound off, then release the button. The message “**unitS**” is displayed, then press **MENU** button until the message “**AUTO 0**” is displayed, then press **PRINT** to confirm

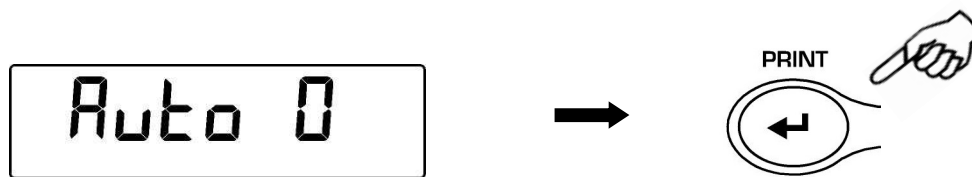

2. Pressing **MENU** or **CAL** button it will be possible to scroll forward or backward through the different autozero levels, select the one you wish and confirm it by pressing the **PRINT** button

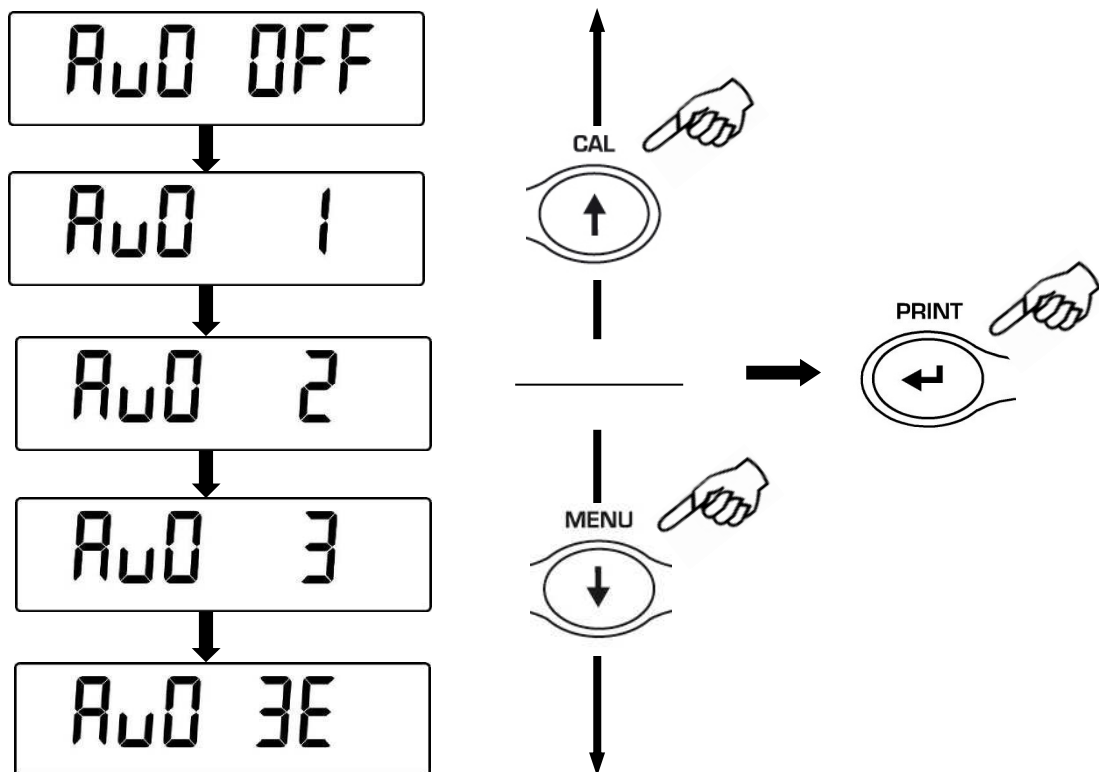

3. After having selected the autozero level you wish, press the **MENU** button to go to next parameter or **CAL** button to go to previous one.
4. To escape from parameters setup menu, press the **MENU** button until to buzzer sound off, then release the button.
5. The balance will return to standard weighing conditions.

## 9.6 Filters selection

It is possible to adapt the balance to the different environment conditions thanks to the selection of three filters:

- **FILTER 1:** proportion of ingredients condition
- **FILTER 2:** stable conditions
- **FILTER 3:** unstable conditions

1. From zero condition on display, press and keep pressed the **MENU** button until to buzzer sound off, then release the button. The message “unitS” is displayed, then press **MENU** button until the message “FILTER” is displayed then confirm it by pressing the **PRINT** button

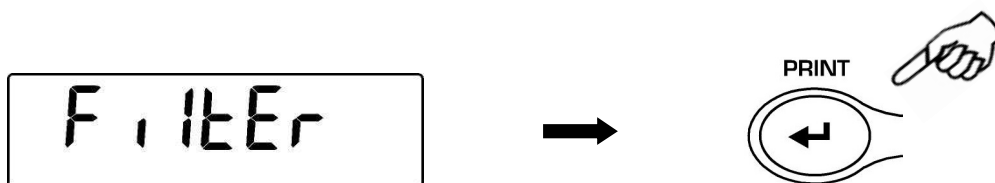

2. Pressing **MENU** or **CAL** button it will be possible to scroll forward or backward the different filtering levels, select the one you wish and then confirm it by pressing the **PRINT** button

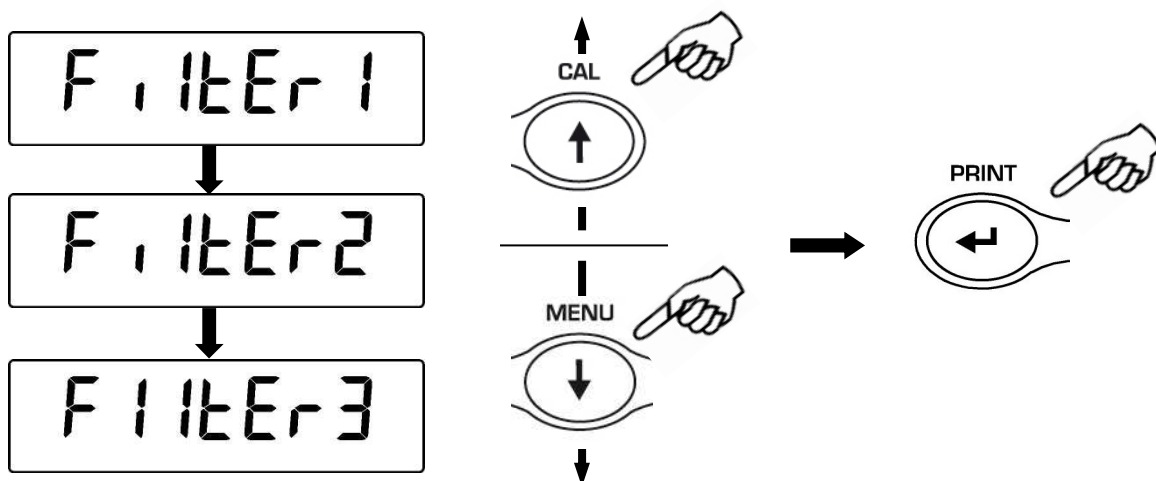

3. After having selected the filtering level you wish, press the **MENU** button to go to next parameter or **CAL** to go to previous one.
4. To escape from parameters setup menu, press the **MENU** button until to buzzer sound off, then release the button.
5. The balance will return to standard weighing conditions



**NOTE:** It is suggested to use FILTER 1 when proportion of ingredients must be performed

## 9.7 Stability function

The stability symbol is displayed when the weight is stable inside a defined range

- **STAB 1** = for stable environments
- **STAB 2** = for not so stable environments
- **STAB 3** = for unstable environments

1. From zero condition on display, press and keep pressed the **MENU** button until to buzzer sound off, then release the button. The message “**unitS**” is displayed, then press **MENU** button until the message “**StAbiL**” is displayed, then confirm this by pressing the **PRINT** button.
2. Pressing **MENU** or **CAL** button it will be possible to scroll forward or backward the different stability levels, select the one you wish and then confirm it by pressing the **PRINT** button.

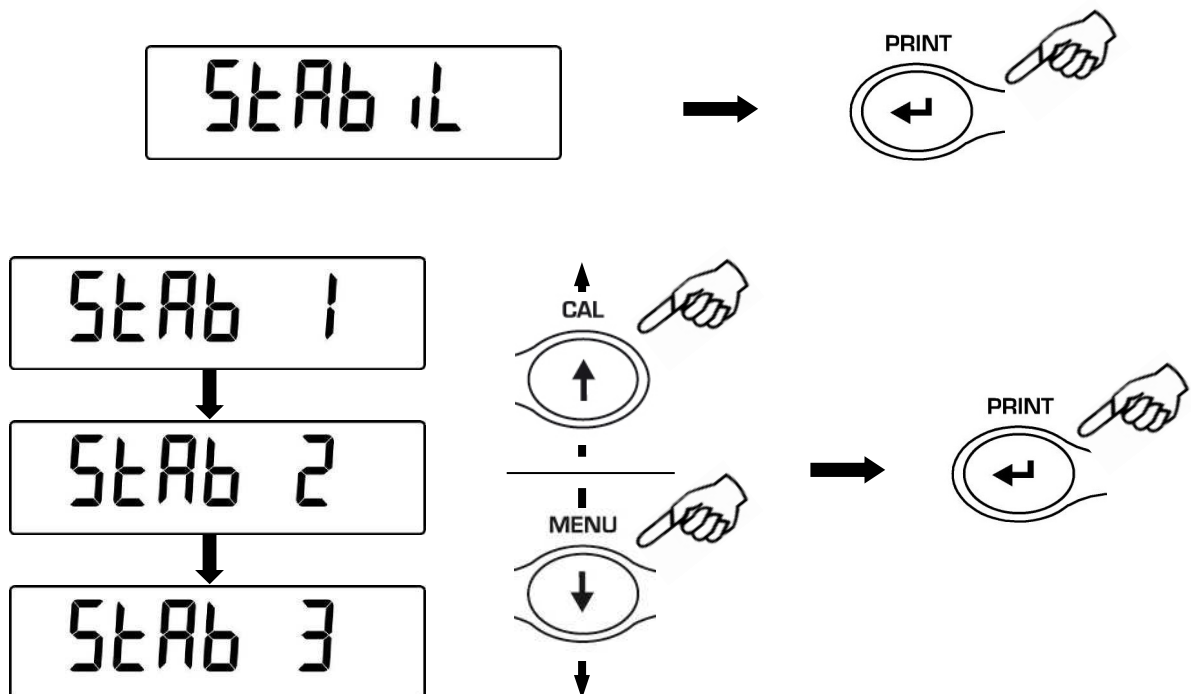

3. After having selected the stability level you wish, press the **MENU** button to go to next parameter or the **CAL** button to go to previous one.
4. To escape from parameters setup menu, press the **MENU** button until to buzzer sound off, then release the button.
5. The balance returns to normal weighing conditions.



## 9.8 Display Contrast regulation

It is possible to regulate the contrast level of display to have a comfortable view of the indication at different angles of usage.

There are 15 different levels of regulation:

1. From zero condition on display, press and keep pressed the **MENU** button until the acoustic signal gets mute, then release the button. The message “**units**” is visualized, now press the **MENU** button repeatedly until the message “**contr**” is displayed and confirm this by pressing the **PRINT** button

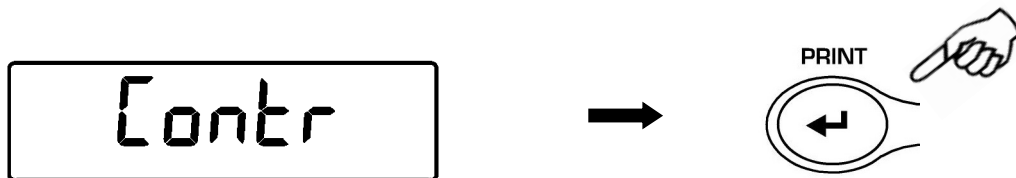

2. Now, pressing the buttons **MENU** or **CAL** it is possible to increment or decrement the level of the display contrast; select the one desired and confirm by pressing the **PRINT** button.

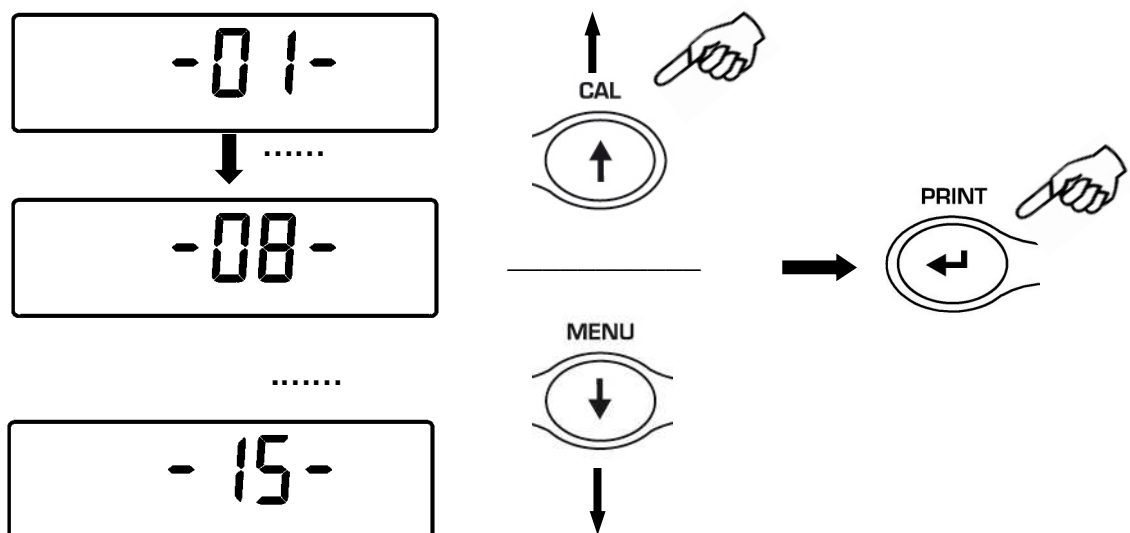

3. After you have confirmed the contrast level desired, press the **MENU** button to go to the next parameter or the **CAL** button to go to previous one.
4. To escape from parameters setup menu, press the **MENU** button until the acoustic alarm gets mute, then release the button.
5. The balance returns to normal weighing mode



## 9.9 Display Backlight setup

The balance display is equipped with backlight to make the indication more visible also during low light conditions.

There are 3 working modes:

- **ON** = light always switched ON
- **OFF** = backlight always switched OFF
- **AUTO** = backlight automatically switched on during weighing operations

1. From zero condition on display, press and keep pressed the **MENU** button until the acoustic alarm gets mute, then release the button. The message “**unitS**” is displayed, then press **MENU** button until the message “**bLt**”, then press the **PRINT** button to confirm this.

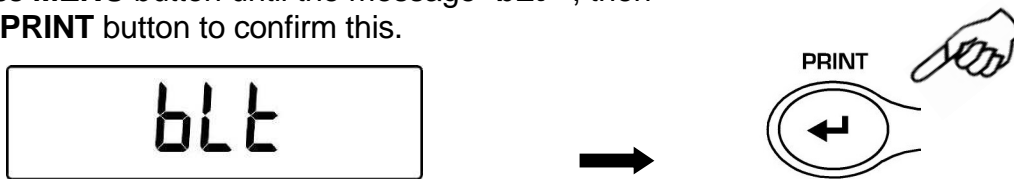

2. Pressing **MENU** or **CAL** button it will be possible to scroll forward or backward the different working modes, select the one you wish and then confirm it by pressing the **PRINT** button

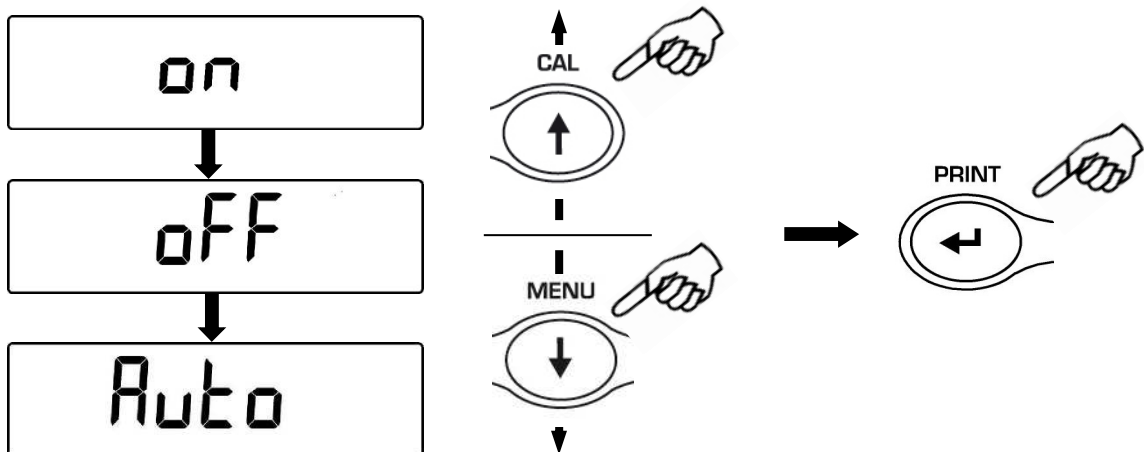

3. After having selected the backlight working mode you wish, press the **MENU** button to go to next parameter or the **CAL** button to go to previous one.
4. To escape from parameters setup menu, press the **MENU** button until the acoustic alarm gets mute, then release the button.
5. The balance returns to normal weighing conditions.





## 9.10 Selection of working mode with Tablet

Using the appropriate connection box, connect the tablet to the serial output of the balance.

1. From condition of zero on display, press and hold the **MENU** button until the acoustic signal is over, then release the button. The message “**units**” is displayed, press the button **MENU** until the message “**TBL MODE**” is displayed and confirm pressing **PRINT** button

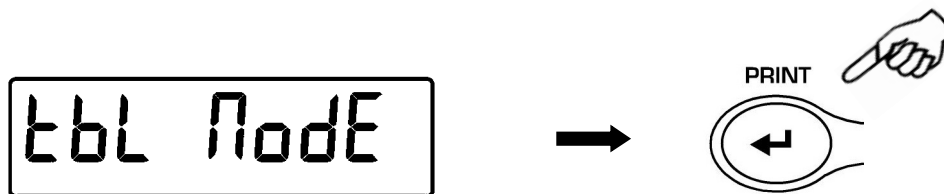

2. To choose the working mode with tablet, press the **MENU** button until you visualize the message “**TBL ON**”, then press **PRINT** to confirm

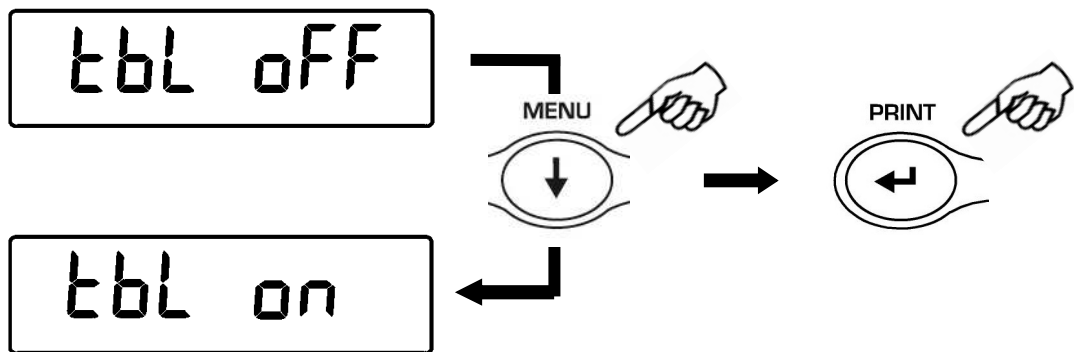

3. After you have chosen the mode “**TBL ON**” the balance will automatically restart and the message “**TABLET**” will appear on the display of balance. From this moment the interface device with the balance is the tablet.

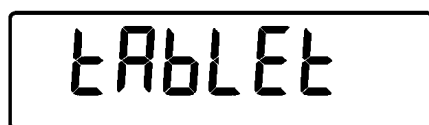

4. To escape from “**TABLET**” mode, press the **MENU** button , then **PRINT** button.

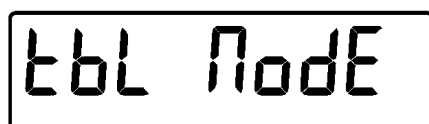

5. Press the **MENU** button until you visualize the message “**TBL OFF**” , then press **PRINT** to confirm the selection.

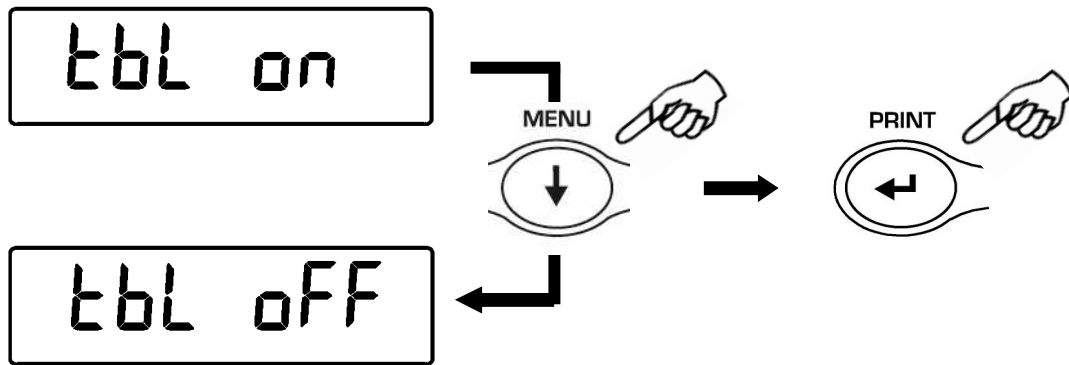

6. After you confirm with the **PRINT** button, the balance will restart automatically and will return to standard working mode.

### 9.11 Calibration Mode

This balance can be calibrated only with external weight.

1. From condition of zero on display, press and hold the **MENU** button until the acoustic signal is over, then release the button. The message “**unitS**” is displayed, press the button **MENU** until the message “**Calib**” is displayed and confirm pressing **PRINT** button

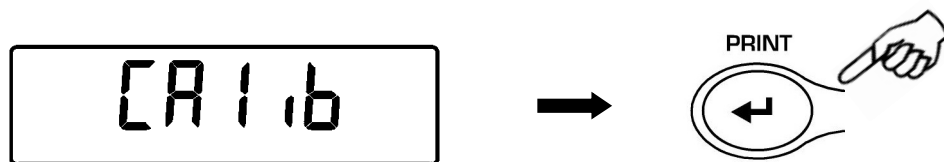

2. The message “**E-Cal**” is displayed.

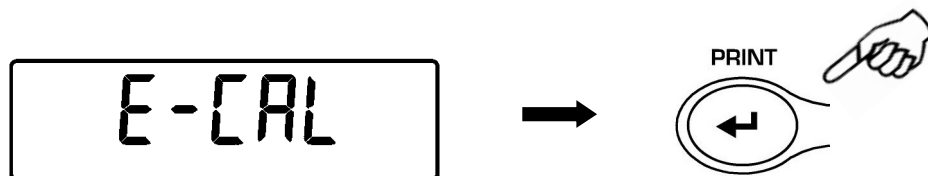

3. Confirm pressing **PRINT** button

## 10 How to set Heater's functions

**Attention:** The minimum amount of substance required to perform the analysis of moisture content depends on the resolution of the instrument:

- For models with a resolution of 0.01 g and 0.001 g is 500mg
- For models with resolution 0,0001g is 50mg

### 10.1 Measure Function

This function allows you to enter the selection of the drying method:

1. From condition of zero on display, press and hold the **MENU** button. The message "**Measure**" is displayed and confirm pressing **PRINT** button

**PrG 1** Drying mode using the stored program 1

**PrG 2** Drying mode using the stored program 2

**PrG 3** Drying mode using the stored program 3

**PrG 4** Drying mode using the stored program 4

**PrG 5** Drying mode using the stored program 5

**PrG time** Time drying mode

**PrG Auto** Autostop drying mode

2. Pressing the **MENU** or **CAL** buttons to scroll forward or backward the different drying modes, then select the you choice and confirm it using the **PRINT** button.

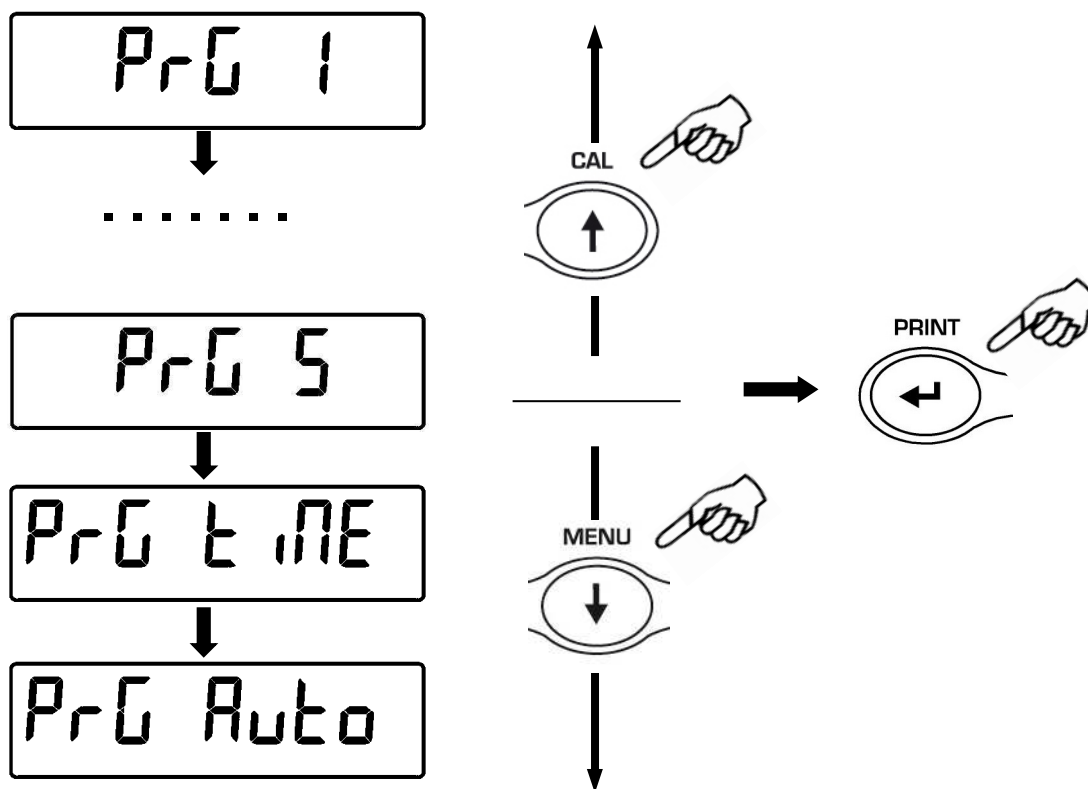

### 10.1.1 Mode using a saved program

Selecting one of the modes PrG 1 PrG 2 PrG 3, PrG 4 PrG 5 it is possible to recall a drying program previously stored.

After selecting the desired program, press ENTER to confirm. You will read on display the following message:

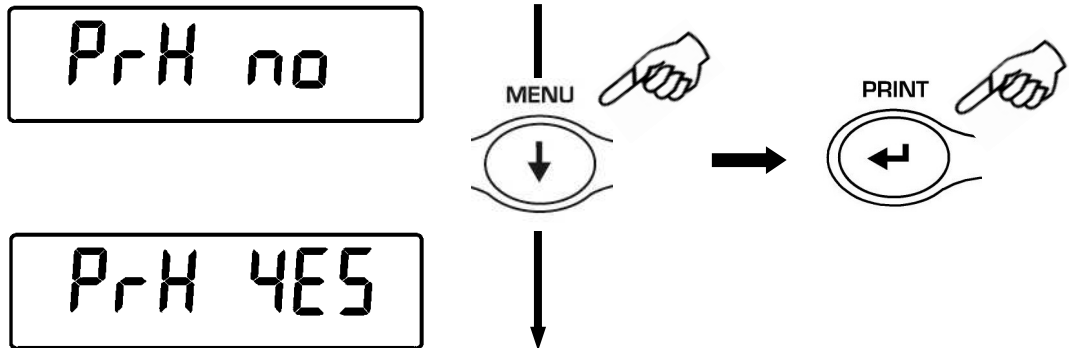

Use the MENU button to activate (“YES”) or deactivate (“NO”) the function of pre-heating of the heater. This function allows to bring and to keep the heater temperature to the value set before the start of the drying cycle. The choice will be kept memorized until the instrument is switched off.

If the function is activated after the ENTER button has been pressed, then the WAIT message will be displayed.



As the set temperature is reached, it will be maintained and the display will show the following message:

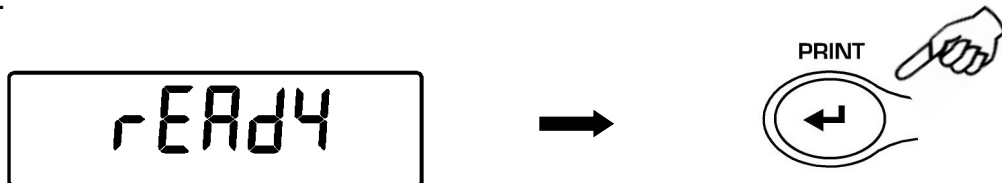

Press the ENTER button to go on

It is now visualized weight indication along with the symbol ▼.

If the function is disabled, after pressing the ENTER button to confirm the selection it will be directly displayed the weight value.

Effect the Tare if necessary and load the sample to examine, wait for stability and then press ENTER to let start the drying cycle.

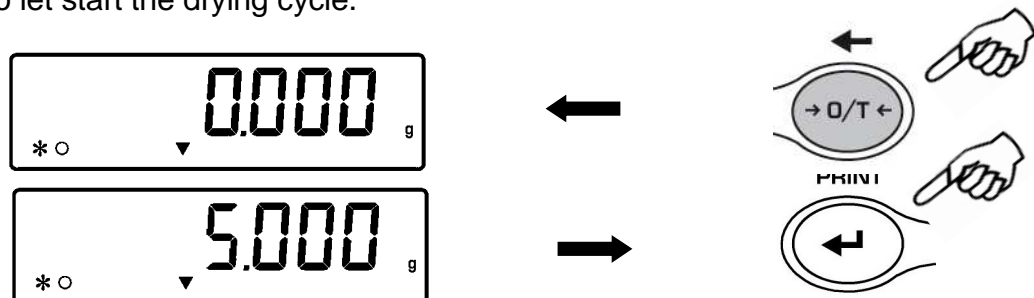

During drying cycle it will be visualized the symbol H (=heater is working).

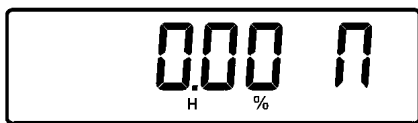

It is also possible to see the drying parameters pressing sequentially the MENU button:  
It is possible to stop the cycle at any moment pressing the ON/OFF button.

Please read the section “Prg Set Function” to know how to store programs

### 10.1.2 PrG time mode

Selecting this drying mode it is possible to set the proper temperature and drying time values.

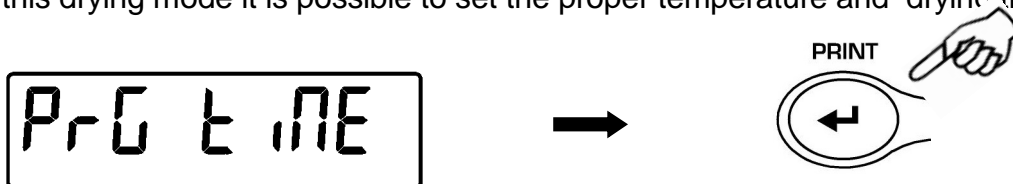

After you confirm the Prg TIME mode, it is first asked to set the duration of the cycle and then the value of drying temperature.

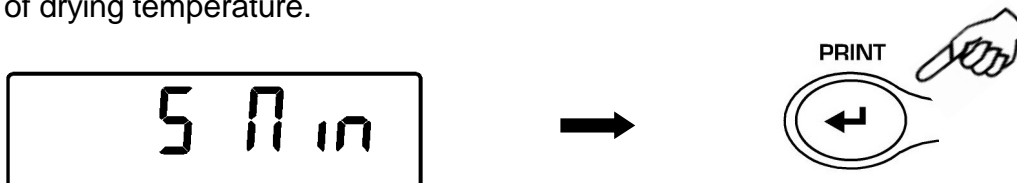

The time can be set from 1 to 99 minutes using the CAL and MENU buttons to increase or decrease the value of time, then confirm with the ENTER button.

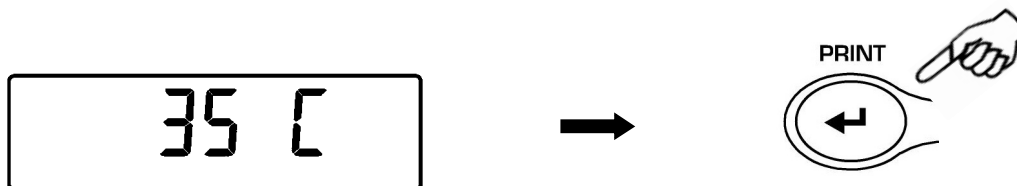

Set now the chosen temperature using the CAL and MENU buttons to increase and decrease the value of temperature, then confirm using the ENTER button.  
The following message is then displayed:

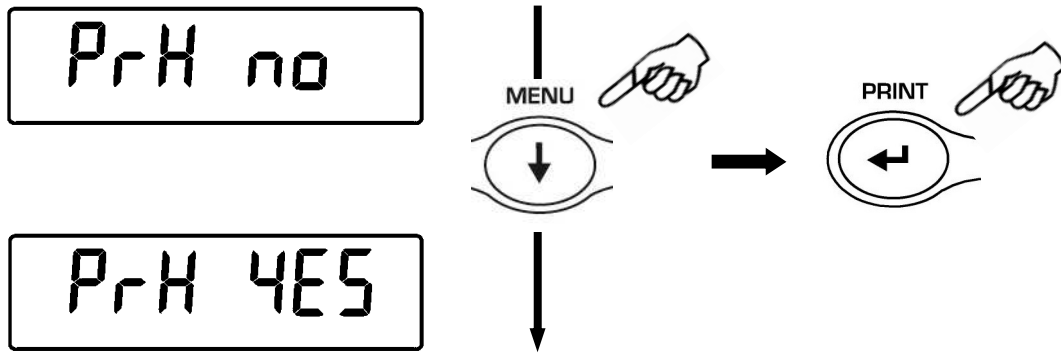

Use the MENU button to activate (“YES”) or deactivate (“NO”) the function of pre-heating of the heater. This function allows to bring and to keep the heater temperature to the value set before the start of the drying cycle. The choice will be kept memorized until the instrument is switched off.

If the function is activated after the ENTER button has been pressed , then the WAIT message will be displayed.

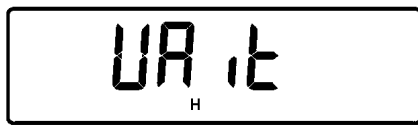

As the set temperature is reached, it will be maintained and the display will show the following message:

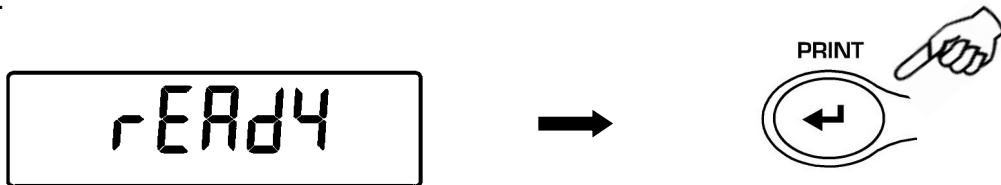

Press the ENTER button to go on.

It is now visualized weight indication along with the symbol ▼ .

If the function is disable ("NO") after pressing the ENTER button to confirm the selection it will be directly displayed the weight value.

Effect the Tare if necessary and load the sample to examine, wait for stability and then press ENTER to let start the drying cycle.

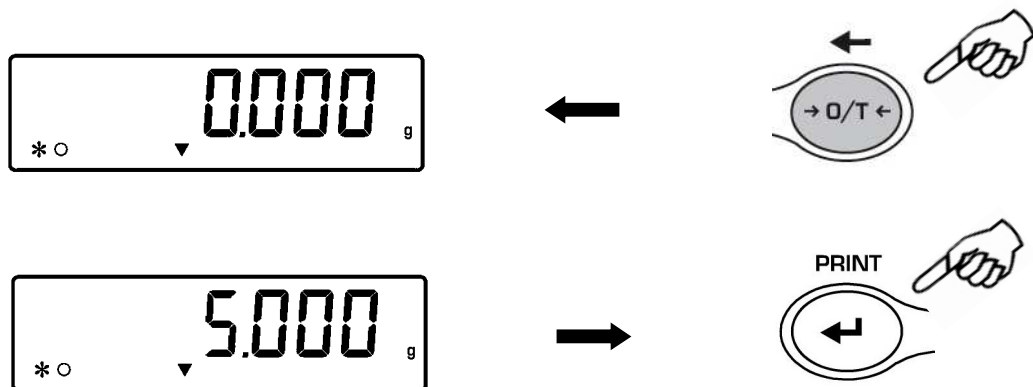

During drying cycle it will be visualized the symbol H (heater is working).

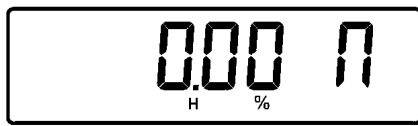

It is possible to stop the cycle at any moment pressing the ON/OFF button.  
It is also possible to see the drying parameters pressing sequentially the MENU button:

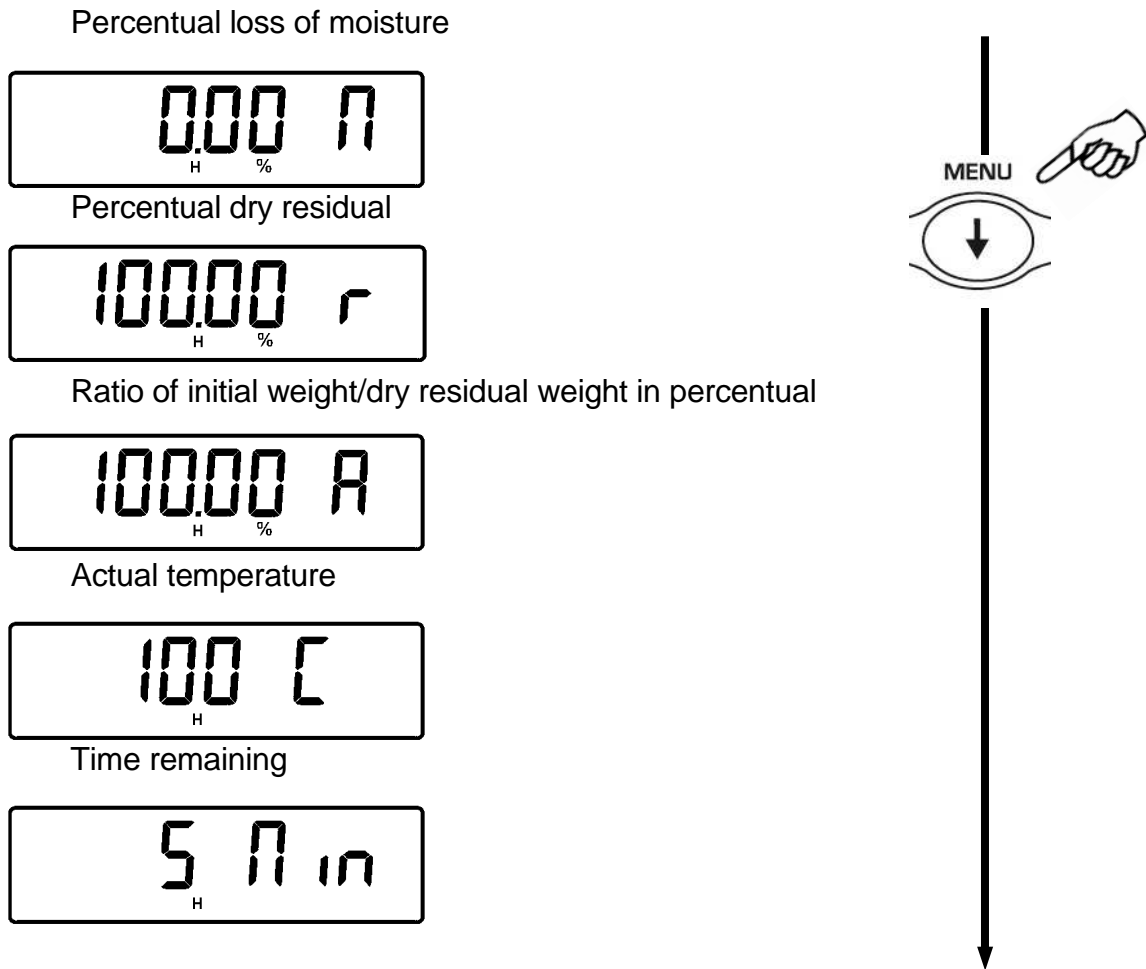

At the end of the cycle the instrument will give out an acoustic signal for about 15 seconds and on the display it will be visualized the final value with the OK symbol (=cycle is finished).



Press the ON/OFF button to escape and to go to the next sample to examine.

### 10.1.3 PrG Auto Mode

Selecting this mode it is possible to activate the automatic drying mode. Setting the value of temperature and the chosen value of minimum moisture loss (time interval 60sec), the balance will stop automatically the drying process when the moisture loss will go below the value set by the user.

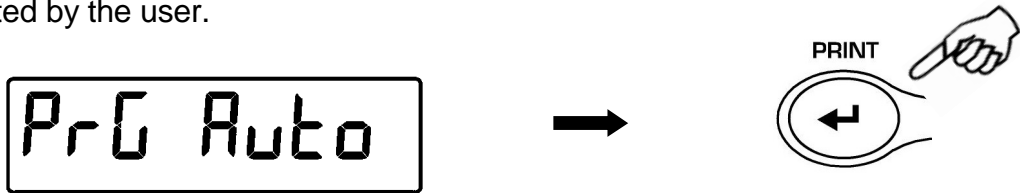

Insert the value of desired percentual minimum moisture loss in the range 0.1 – 9.9% , using the CAL and MENU buttons to increase and decrease this value, then confirm using ENTER.



Now set the proper chosen temperature using CAL and MENU to increase and decrease the value of temperature, then confirm using ENTER.

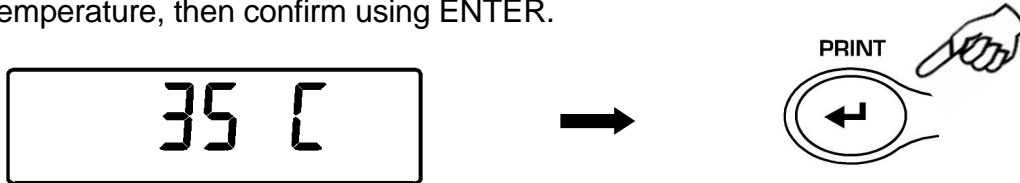

The following message will be displayed

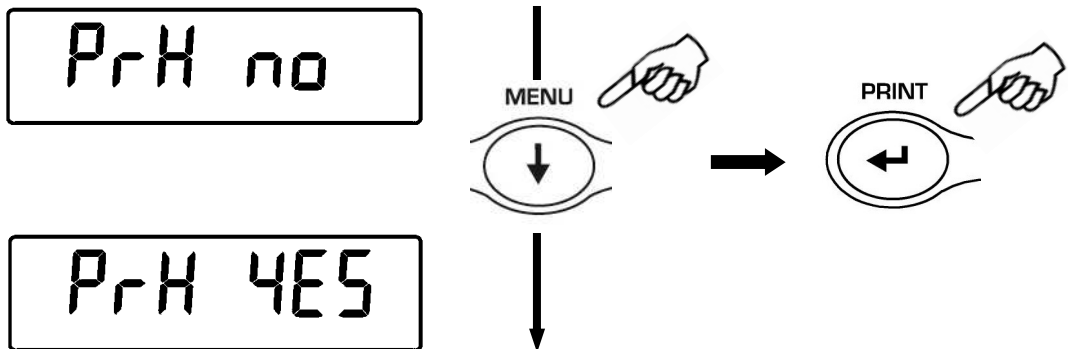

Use the MENU button to activate (“YES”) or deactivate (“NO”) the function of pre-heating of the heater. This function allows to bring and to keep the heater temperature to the value set before the start of the drying cycle. The choice will be kept memorized until the instrument is switched off.

If the function is activated after the ENTER button has been pressed , then the WAIT message will be displayed.





As the set temperature is reached, it will be maintained and the display will show the following message:

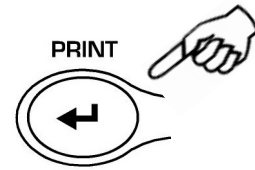

Press the ENTER button to go on.

It is now displayed the weight indication along with the symbol: ▼ .

If the function is disabled after pressing the **ENTER** button to confirm the selection it will be directly displayed the weight value.

Effect Tare if necessary and load the sample to examine, wait for stability and press ENTER to let the drying cycle start.

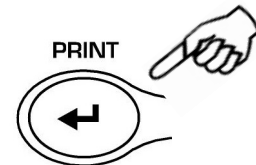
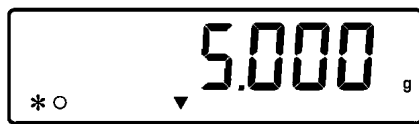
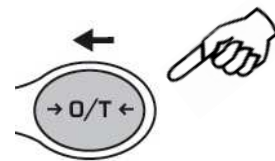

During drying cycle it will be visualized the symbol H (=heater is working).

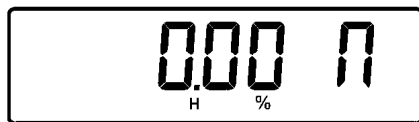

It is possible to stop the cycle at any moment pressing the ON/OFF button.

During the drying cycle it is possible to see the drying parameters pressing sequentially the MENU button.

When the rate of moisture loss is below of setted valure, automatically the drying process is stopped and the buzzer soun will be for about 15 seconds, on the display it is visualized the analise result with the symbol OK (=cycle is finished).

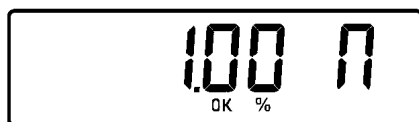

Press the ON/OFF button to escape and to go to the next sample to examine.

## 10.2 Prg Set Function

This function allows to store upto 5 different drying programs (Prg1, Prg2, Prg3, Prg4, Prg5)

1. From condition of zero on display, press and hold the **MENU** button until the acoustic signal is over, then release the button. The message "**Measure**" is displayed, press the button **MENU** until the message "**Prg Set**" is displayed and confirm pressing **PRINT** button

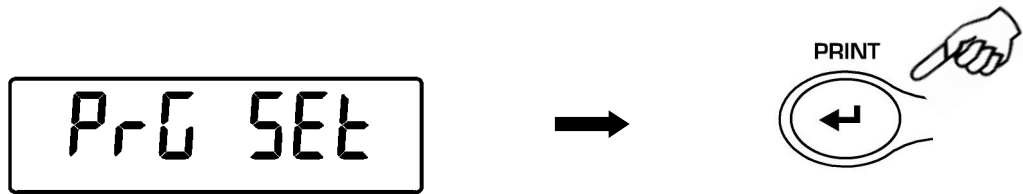

2. It is displayed the program Prg 1 , press the MENU or CAL to scroll forward or backward the drying programs, then select the one desired pressing the PRINT button

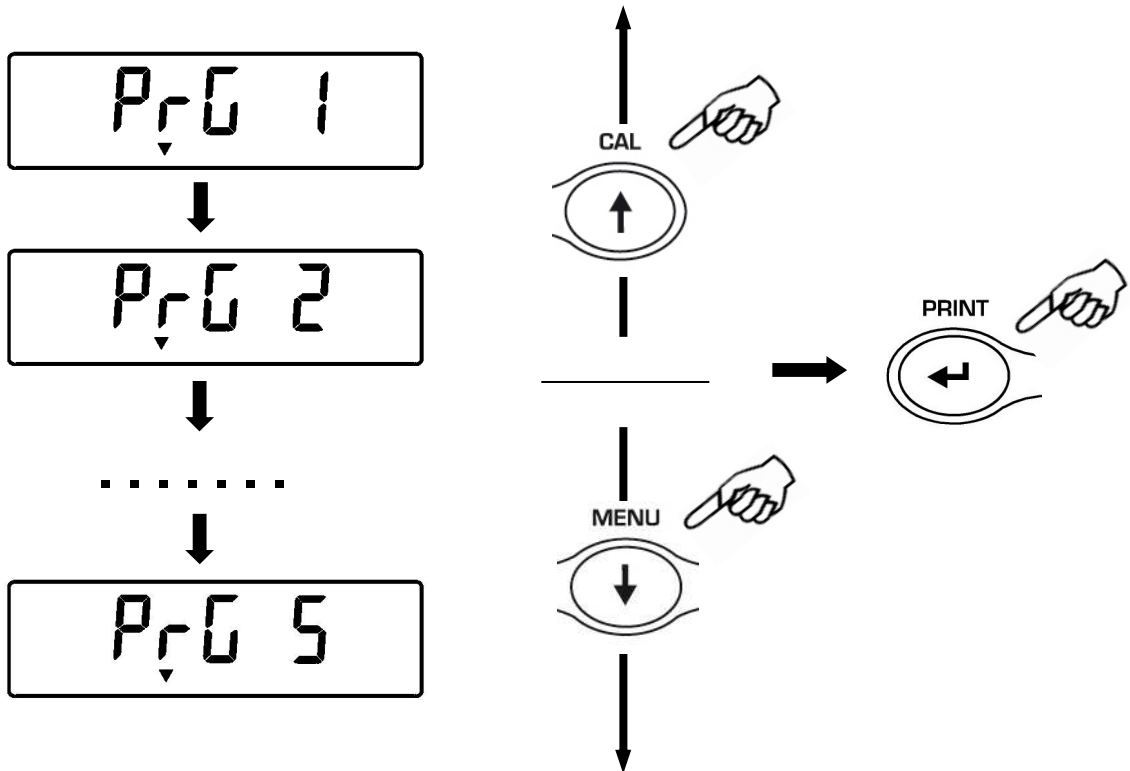

3. After having selected the program, choose the desired drying mode, Time Mode or Auto Mode.
4. Depending on the chosen mode, insert drying parameters as described in the section 10.1.2 for the time mode, and in the section 10.1.3 for the automatic mode.
5. It is now asked if the data that has been set must be saved or not:

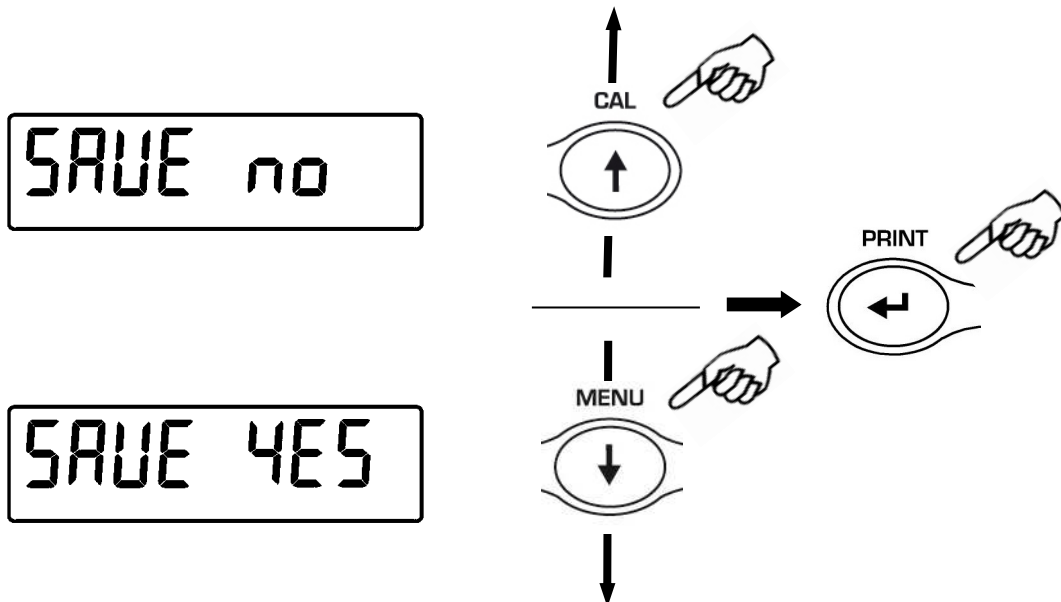

Use the MENU and CAL buttons to choose Yes or No. Then confirm with ENTER. Then the program is saved and the previous one is deleted. It is now possible to store another program or it is possible to escape from the programs menu using the ON/OFF button.

# 11 RS232 interface features

## 11.1 General features

The balance transmits the value visualized on its display using serial RS232C standard, allowing to print the value of weight and relative drying data to a PC monitor or to a serial printer. Both in the print to PC mode and in the print to Printer mode, it is possible to select the automatic transmission (“Auto”) or manual transmission (“Manu”) pressing the PRINT button( as described in section “Serial function”). Also, it can receive commands from PC when the balance is set in PC mode, always in RS232C format; this allow you to perform all the operations usually accomplished with balance buttons through the keys of your PC keyboard. The speed of transmission and reception can be selected as previously described (section 9.1) at 1200, 2400, 4800, and 9600 baud. The character format is of 8 bit preceded by one bit of start and followed by a bit of stop. Parity is not applied.

**N.B.:** Serial data transmission is activated only after the drying cycle is entered, with the heater cover closed.

## 11.2 Connecting the balance to PC

For the transmission of the data, connect the connector 1 located behind the hoven to the serial port of the PC, as illustrated in the following drawing :

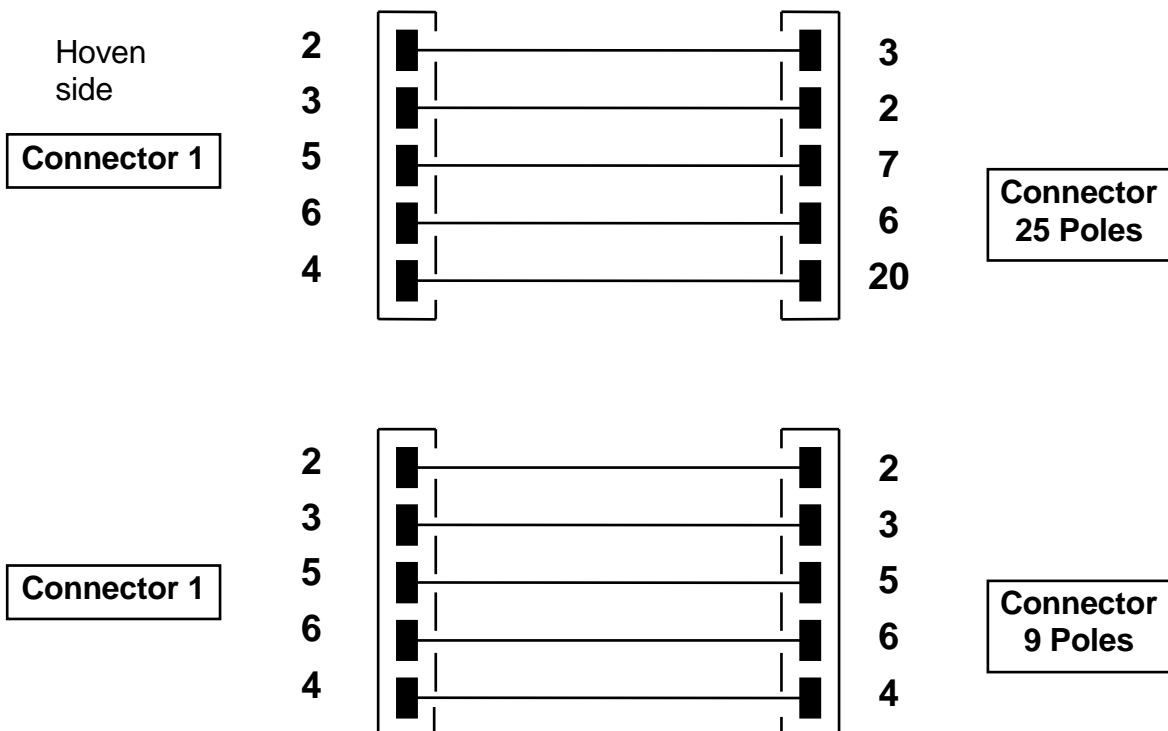

### 11.3 Transmission format when in PC connection mode

In the following table are shown the different transmission formats:

#### Weig PC

1°	2°	3°	4°	5°	6°	7°	8°	9°	10°	11	12	13	14	15
Sign	Value of weight								space	g	space	Stability	CR	LF

#### Manu PC / Auto PC in weight mode

1°	2°	3°	4°	5°	6°	7°	8°	9°	10°	11	12	13	14	15
Sign	Value of weight								space	g	space	Stability	CR	LF

## 11.4 Connection of the balance with the serial printer

To print the value of weight, connect a serial printer to the connector 1 of the balance as shown in the following drawing:

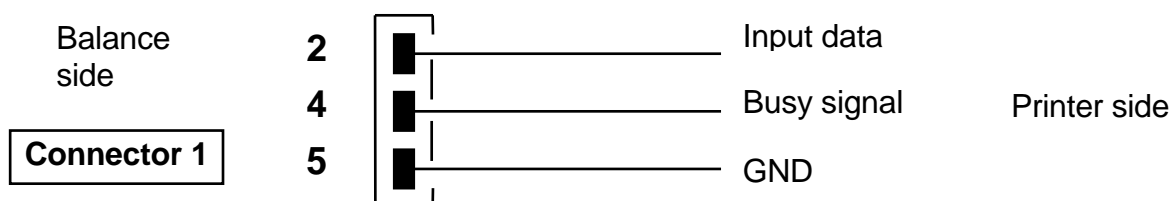

## 11.5 Print formats on paper with serial printer

Selecting the transmission mode to serial printer, the balance's serial output will be set to work with serial printers. To select the type of printer, refer to the section 9.2.

The connector to be used for the connection is the No. 1. (See Figure 1 next page)

If it is used the optional printer model TLP50 it is possible to print both in continuous module and in labels with the following formats :

Manu Prt/T50

```
12-02-2008      12:00
Temp.    130 'C
Time:    5 Min
W.Start  19.998 g
-----
W.End:   19.994 g
Moist.:  0.02 %
-----
```

Auto Prt/T50

At beginning of the cycle

```
12-02-2008      12:00
Temp.    130 'C
Time:    5 Min
W.Start  19.997 g
-----
```

At the end of the cycle

```
12-02-2009      12:00
W.End:   19.986 g
Moist.:  0.05 %
-----
```

## 12 Connectors position (rear)

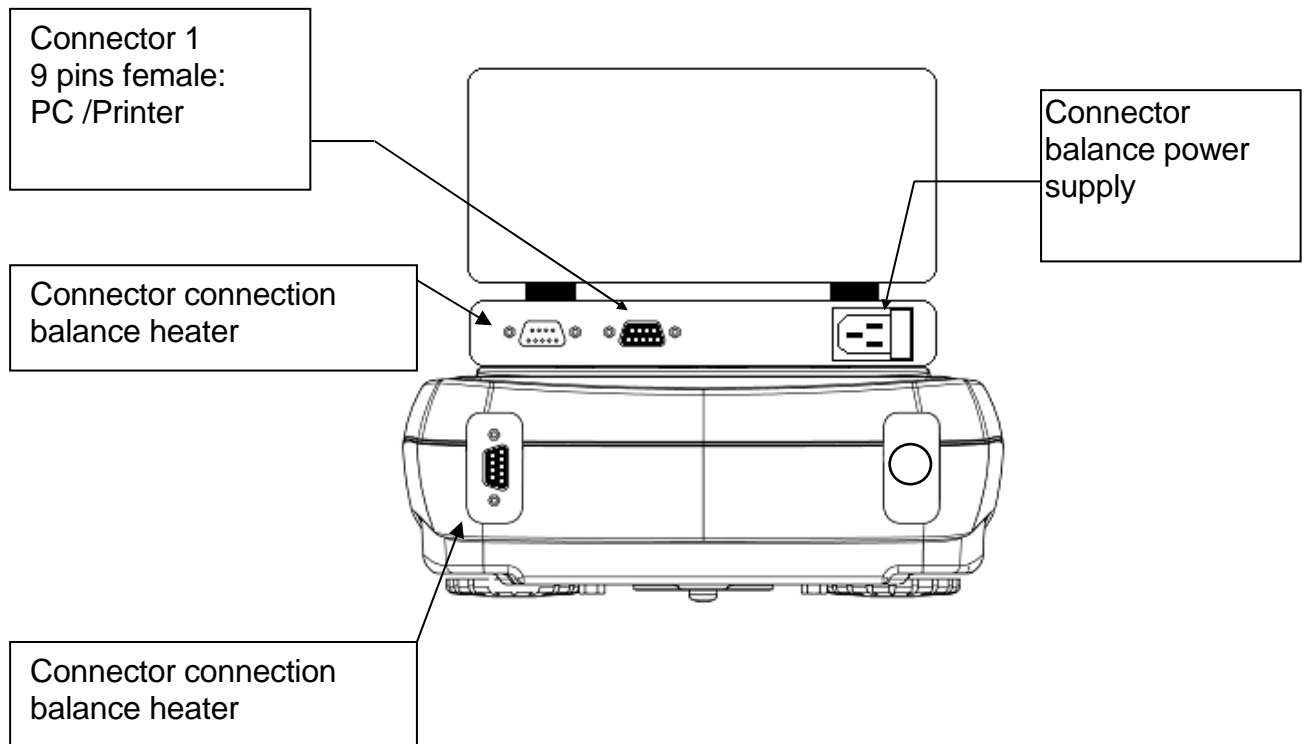

Fig. 1 Rear side of the balance

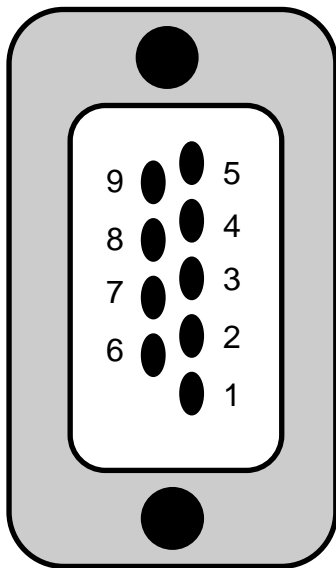

Fig. 2

### CONNECTOR 1 PINS FOR KEYBOARD OR PC OR PRINTER

- pin 1 = Power +5V for keyboard
- pin 2 = Tx signal
- pin 3 = Rx signal
- pin 4 = busy signal
- pin 5 = Gnd
- pin 4-6 = connected to each other for connection to PC

Fig. 3

## 13 Error codes

- **ERR01:** the weight does not reach stability after a tare operation ⇒ Protect the balance from air flows or from vibrations of the working table.
- **ERR02:** impossible to start the calibration operation due to balance instability ⇒ Protect the balance from air flows or from vibrations of the working table.
- **ERR03:** calibration weight not correct or balance unstable ⇒ Calibrate with correct weight or protect the balance from environment disturbs.
- **ERR05:** print not allowed due to balance instability ⇒ Protect the balance from environment disturbs.
- **ERR07:** error in insertion data.
- **ERR10:** the weight does not reach stability before start of dry ⇒ Protect the balance from environment disturbs.
- **ERR11:** weight of substance not enough ⇒ Increase quantity of substance .
- **“UNLOAD”:** weight loaded on the pan or pan not positioned properly ⇒ Remove the weight from the pan or position properly the pan and underpan.



- : Overrange condition ⇒ Unload the weights loaded on the pan.



- : Underrange condition ⇒ Place properly pan and underpan.

## 14 Maintenance and care

Regular maintenance of yours balance guarantee accurate measurements.

- **Cleaning**

Before cleaning the balance unplug the power supply of the balance from the voltage supply of your room. Do not use aggressive cleaning product (as solvents or similar), use a humid towel with soft detergent, avoid liquids to penetrate inside the instruments during the cleaning. Wipe the balance with a soft towel. Parts of samples or powder can be removed using a brush or vacuum cleaner.

- **Safety checks**

Safety of the instrument is no more guaranteed when:

- balance power supply is clearly damaged
- balance power supply is not working anymore
- balance power supply is stored for long time in hard environment conditions.

In these instances refer to the assistance center where specialized technician will make reparations to bring back the instrument in the safety conditions eventually.



## 15 Quick guide to balance parameters settings

- To enter the balance parameters setup menu, press and keep pressed the **MENU** button until the acoustic alarm is over.
- Use then the **MENU** button to go to next parameterer, use the **CAL** button to go to previous and the **PRINT** button to cofirm the choice.
- To escape from menu, press the and keep pressed the **MENU** button until the acoustic alarm is over

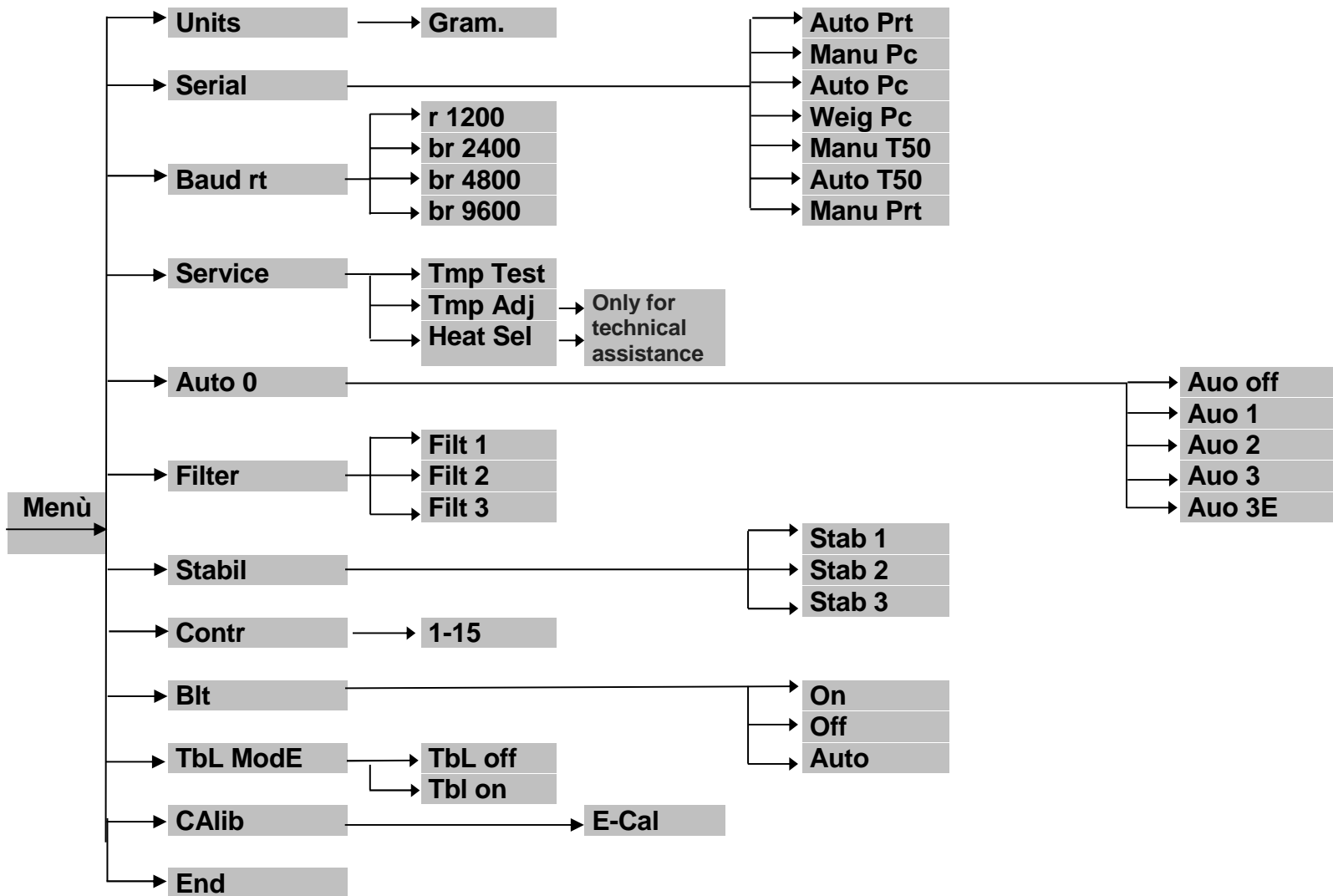

## 16 Quick guide to the use of the balance's programs

- To enter the menu of balance programs press the **MENU** button.
- Then use the **MENU** button to go to the next parameter, use the **CAL** button to return to previous parameter, use the **PRINT** button to confirm your selection.
- To escape from the menu press and keep pressed the **MENU** button until the acoustic sound is over.

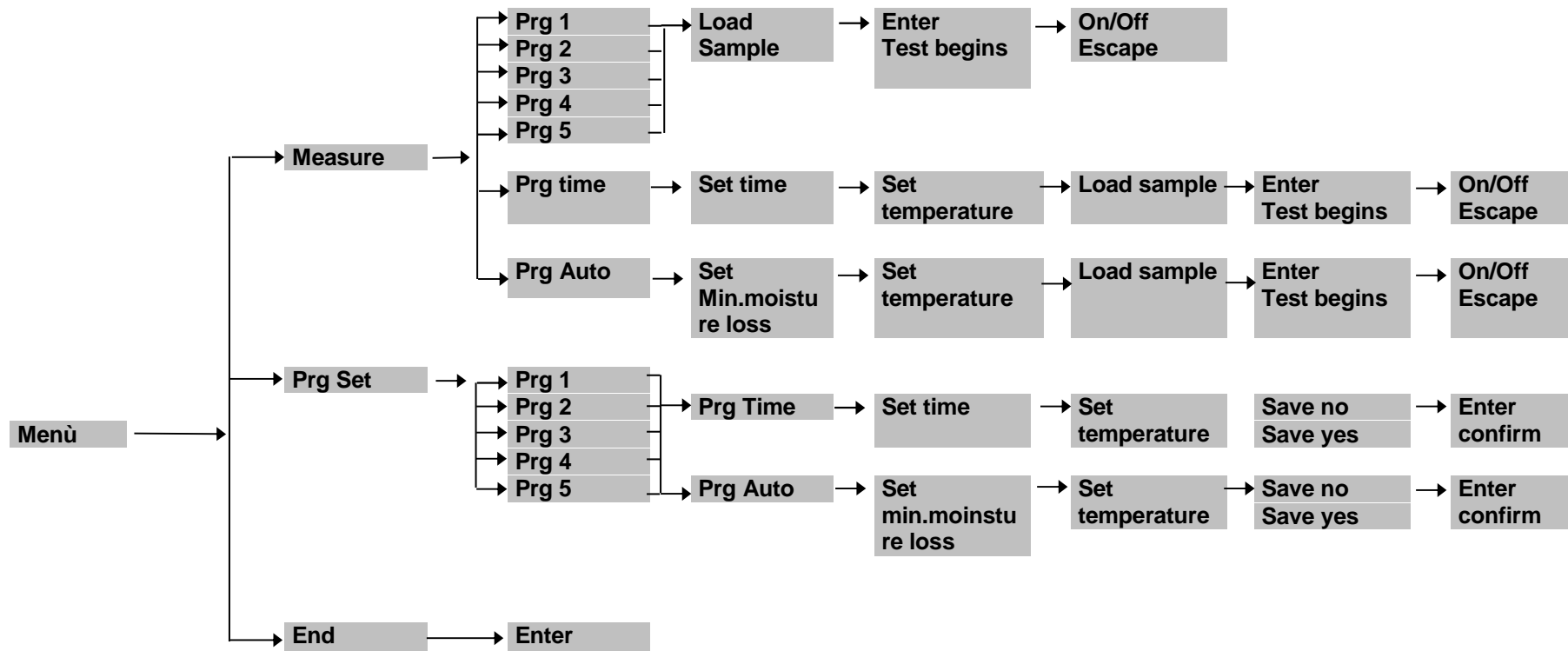

## 17 Balance Technical features

All the models listed all only for internal use.

Maximum altitude using limit: 4000m.

Pollution level: 2.

Overvoltage category: II

Power supply tension	230V 50Hz or 110V 60Hz (at request)
Absorbed power	400 VA
Fuse	For <b>230V</b> : 250V 3.5A dimensions 5x20mm; For <b>110V</b> : 250V 6.3A dimensions 5x20mm
Enviroment condition adaption:	Selectable filters
Autozero:	Selectable from Menu
Serial output:	RS232C
Operating temperature range:	+5°C - +35°C

## 18 Heater technical features

**Access to samples room:** cover with wide opening angle

**Temperature working range:** 35 – 160 °C, that can be set with steps of 1°C

**Switch-off method:** automatic or at time that can be set from 1 to 99 minutes with steps of 1 minute

**Heating:** halogen lamp

## 19 Warranty

- Duration of warranty is of 24 months from the date of purchase proved by invoice concerning the product or by delivery note.
- Warranty covers all parts resulting defective at the origin. It does not cover mechanical or electronic parts damaged by wrong installation, tampering or incorrect use.
- Warranty does not cover damages caused by impacts, balance drops or drop of objects on weighing pan.
- Shipment to and from service center is at customer charge

## 20 Equipment Disposal



If the package is not used anymore, it can be given to the local disposal center. The package is completely made of not pollutants materials, recyclables as valuable secondary raw materials. Exhausted batteries must NOT be disposed in the usual domestic garbages. They must be thrown in the right disposal containers. In case of equipment destruction please contact your local authorities. Before destruction of equipment remove the batteries.